



2020

INDEX

8

**E-MOTION /
ELEKTROBICYKLE**

E-TOUR, E-CROSS, E-RETRO, E-CITY

26

**ROAD RACE /
CESTNÉ**

34

**MOUNTAIN /
HORSKÉ**

54

**ALL TERRAIN /
TREKKINGOVÉ**

64

**CROSS /
KROSOVÉ**

74

LIFESTYLE
COMFORT, RETRO, URBAN

132

YOUTH
MINI, KIDS, TEENS

172

**ACCESSORIES / EQUIPMENT /
DOPLNKY / VÝBAVA**

210

GO SLOVAKIA
BIKESHARING

214

**INFORMATION /
INFORMÁCIE**





#MADE IN SLOVAKIA
#VYROBENÉ NA SLOVENSKU

KENZEL IS A EUROPEAN BICYCLE FACTORY PASSIONATELY COMMITTED TO PROVIDE OUTSTANDING PRODUCTS AND SERVICES. WE SPECIALIZE IN MANUFACTURING OF HI-TEN FRAMES AND FORKS, ALLOY RIMS, WHEELS, POWDER COATING, DECALS AND ASSEMBLING. WE PROVIDE OEM PRODUCTION OF BICYCLES AND PAINTING SERVICES IN A GREAT LOCATION IN THE MIDDLE OF EUROPE. SINCE 1991.

ZAMERIAVAME SA NA VÝROBU OCEĽOVÝCH RÁMOV, VIDLÍČ, VÝROBU RÁFIKOV, POVRCHOVÚ ÚPRAVU A MONTÁŽ BICYKLOV. BICYKLE A KOMPONENTY FARBÍME PRÁŠKOVOU TECHNOLOGIOU A POTLÁČAME VLASTNÝMI NÁLEPKAMI. CELÁ NAŠA VÝROBA PREBIEHA NA SLOVENSKU. OD 1991.

OUR SERVICES

NAŠE SLUŽBY

► Quality craftsmanship



DEVELOPMENT / VÝVOJ

#ALL-IN HOUSE PRODUCTION
#PRODUKCIA NA JEDNOM MIESTE

Our production team has more than 25 years of experience in bicycle industry.



PAINTING / FARBENIE

Náš produkčný tím má viac ako 25 rokov skúseností v oblasti bicyklového priemyslu.



PRINTING / TLAČ



CUSTOMIZATION / PERSONALIZÁCIA



PRODUCTION / VÝROBA



ASSEMBLY / MONTÁŽ

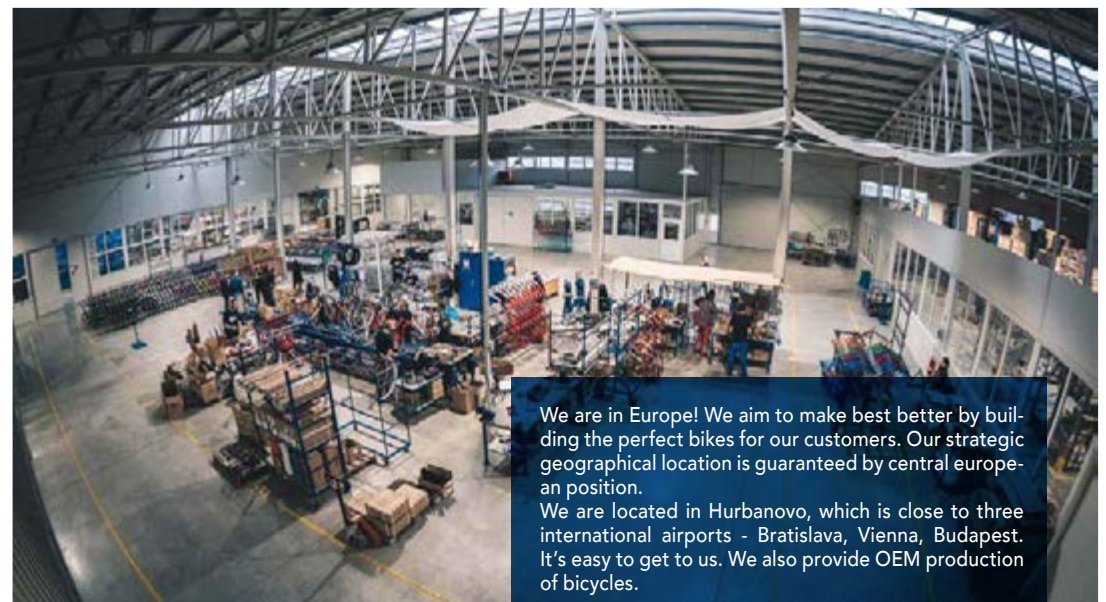

#MADE IN EUROPE
#VYROBENÉ V EURÓPE

We are in Europe! We aim to make best better by building the perfect bikes for our customers. Our strategic geographical location is guaranteed by central european position. We are located in Hurbanovo, which is close to three international airports - Bratislava, Vienna, Budapest. It's easy to get to us. We also provide OEM production of bicycles.

Nášim klientom sa snažíme poskytovať komplexnejšie služby, vyznačujeme sa flexibilitou a kratšími dodacími lehotami.

Sme v Európe! Naša spoločnosť má strategickú geografickú polohu. Nachádzame sa v Hurbanove, ktoré je blízko troch medzinárodných letísk - Bratislava, Viedeň, Budapešť. Náš produkčný tím má viac ako 25 rokov skúseností v oblasti bicyklového priemyslu.

#FRAME & FORK PRODUCTION #VÝROBA OCEĽOVÝCH RÁMOV A VIDLÍC



We produce bicycle steel frames and forks in our own premises. The production program has been expanded by production of industrial racks and stands usable in bicycle production. Your partner for metalworking.

Zaoberáme sa výrobou oceľových rámov a vidlíc. Výrobný program bol rozšírený aj o výrobu priemyselných stojanov používaných v cyklistickom priemysle.

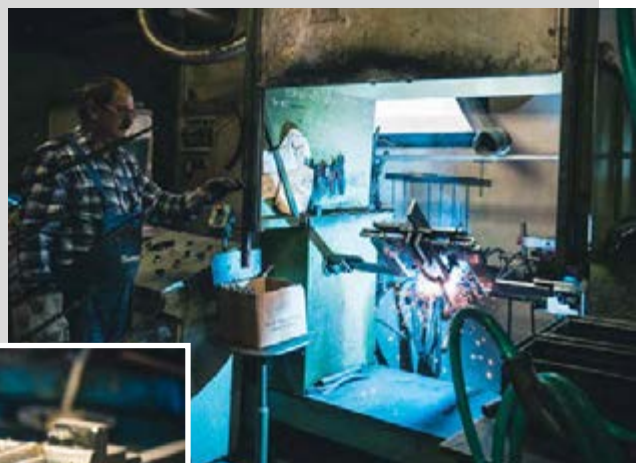

▶ Steel frames and forks



#RIMS & WHEELS #VÝROBA RÁFIKOV A KOLIES

Rims are very important to the entire bicycle, which means manufacturing plays crucial role in the production of wheels. We produce single and double wall aluminium rims from 16" up to 28", optional GBS and powder coating surface finishing. Rims are available for OEM sale.

Výroba ráfikov zohráva dôležitú úlohu v produkcii bicyklov. Venujeme sa výrobe jedностenných a dvojstenných hliníkových ráfikov vo veľkostiach od 16" do 28". Ráfiky sú dostupné aj pre OEM predaj.



OEM BICYCLE AND SPORTING GOODS POWDER PAINTING

#FARBENIE

We start with you on the „bare frame“ and finish with a well designed high-end surface. We follow the electrostatic painting methods. We use Powder clear coating trendy color and effect combinations for your frames and accessories. As highest industry standard.

Kvalita povrchu hrá vždy veľmi dôležitú rolu. Nami používané práškové farby sú bez obsahu škodlivín a ekologického zaťaženia. V našom farebnom portfóliu nájdete vyše 40 farebných odtieňov lesklých, matných, polomatných vrátane metalických a špeciálnych efektov. Výsledkom je presvedčivý produkt, ktorý sa sám predáva.

WE KNOW HOW TO COLOR YOUR PARTS

- ▶ Colours
- ▶ Quality
- ▶ Your OEM professional



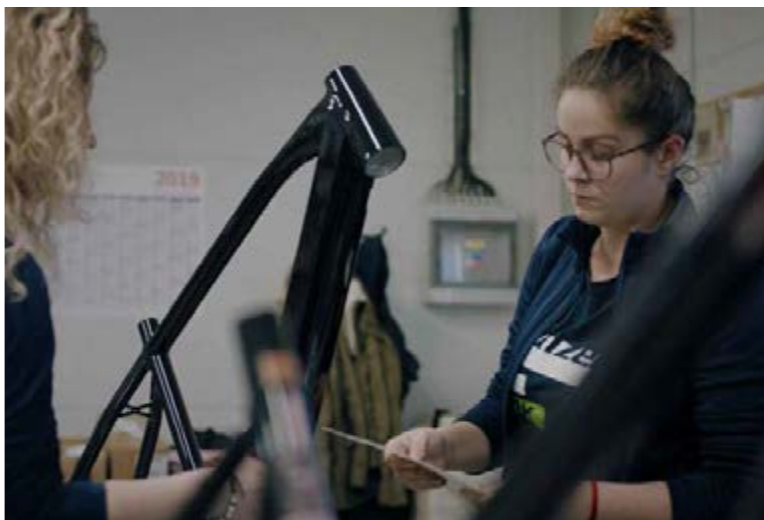

#PRINTING & DECAL DESIGN #TLAČ A DIZAJN NÁLEPIEK

Personality for Your Ride. With a team of experienced graphic designers, we work to provide the optimum solution in decal production to match every detail according to the customer's requirements. Water or PVC decals are transferred in two ways: either on top of or under the clear coating. Our VersaUV printer offers countless product customization including printing directly on 3D objects up to 100 mm thick and on a wide variety of substrates.

Vdýchame Vaším bicyklom osobnosť! S tímom skúsených grafických dizajnérov sa snažíme navrhnuť optimálne riešenia výroby tak, aby výsledok bol v súlade s požiadavkami zákazníka. Naša tlačiareň VersaUV ponúka nespočetné možnosti - dokážeme potlačiť texty, logá, bicyklové objekty a iné predmety až do hrúbky 100 mm.

The assembly line is the main part of the production. Within a few steps, a bicycle is made of the frame and assortment of components. Complete bicycles are stored, ready to ship to customers.

Montážna linka je hlavnou časťou výroby. V priebehu niekoľkých krokov sa z rámu a sortimentu komponentov stáva bicykel. Kompletizované bicykle putujú do skladu, pripravené na expedovanie zákazníkom.

#ASSEMBLY #MONTÁŽ



#CUSTOMIZATION & SAMPLING #PERSONALIZÁCIA

We do it custom. Business to business. From idea to identity. With different countries and cultures we develop the product for each customer to adapt their local market. We support, we innovate, we manage and we produce in EU. Select the existing models or redesign them. Flexible options for small minimum order quantity.

Podporujeme, inovujeme, riadime a vyrábame v EÚ. Vyberte existujúce modely alebo ich prepracujte. Flexibilné možnosti pre malokusové objednávky.



*Customized bikes for OBOS Oslo, Norway
Personalizované bicykle pre OBOS Oslo, Nórsko*

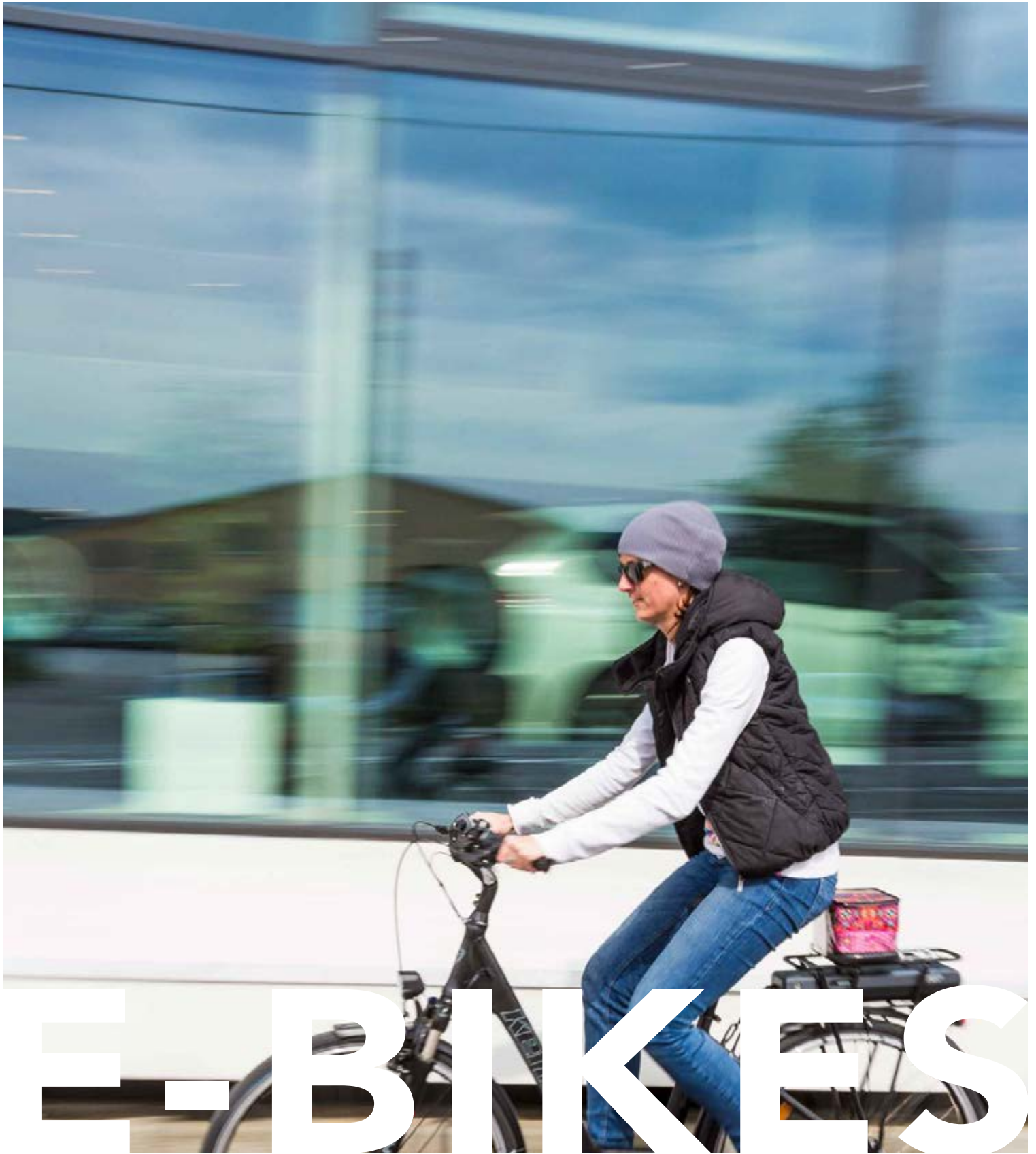

E-BIKES

**RIDE
E-VERY
DAY**

BAFANG

WHAT IS THE DIFFERENCE BETWEEN MID MOTOR AND HUB MOTOR?

AKÝ JE ROZDIEL MEDZI STREDOVÝM A NÁBOJOVÝM MOTOROM?

With a mid-motor, the e-bike's weight is well distributed. A large torque can be delivered to rear hub motor when climbing. A mid motor is better suited for mountainous and hilly areas. A hub motor is easily installed and suitable for flat areas. There is no difference between transmission efficiency.

Vďaka stredovému motoru je hmotnosť bicykla vyvážená. Pri stúpaní môže byť vyvinutý vysoký krútiaci moment na zadný náboj motora. Stredový motor je vhodnejší pre horský a kopcovitý terén. Nábojový motor je vhodný na rovinný terén. Medzi účinnosťou prenosu však nie je žiadny rozdiel.

FRONT / PREDNÝ MOTOR



The front-drive motor, is compatible with a V-brake and has a rated power of 250W. Because of its inner rotor design and a large reduction ratio (1:11), the motor's power can be effectively released. Small in size, light in weight, high in efficiency, and smooth & quiet in running, this motor is suitable for city bikes.

Motor s predným pohonom, ktorý má vnútorný rotor, je kompatibilný s brzdou V a má menovitý výkon 250 W. Vďaka svojej konštrukcii vnútorného rotora a veľkému prevodovému pomeru (1:11) výkon motora je efektívne prenesený. Motor s predným pohonom je malý, s nízkou hmotnosťou, s vysokou účinnosťou a plynulým a tichým chodom je vhodný pre mestské bicykle.

REAR / ZADNÝ MOTOR



The rear-drive motor, which has a rated power of 250W, a reduction ratio of 1: 5 and a maximum torque of 45 Nm, provides ideal power for vehicles. Strong and efficient, this motor greatly enhances riding comfort and is suitable for touring bikes, commuter bikes and mountain bikes.

Motor so zadným pohonom, ktorý má menovitý výkon 250 W, prevodový pomer 1: 5 a maximálny krútiaci moment 45 Nm, poskytuje ideálny výkon. Silný a efektívny, tento motor výrazne zvyšuje pohodlie pri jazde a je vhodný pre turistické bicykle a horské bicykle.

MID / STREDOVÝ MOTOR



The mid-drive motor constantly samples relevant information at a frequency of up to 80 kHz via a torque sensor and two speed sensors which are all highly sensitive. The resulting data on crank torque, vehicle speed and the speed of rotation of the pedals is made available to the controller, ensuring precise control of the vehicle while achieving the highest possible efficiency. The Max Drive System puts the rider in complete control. In spite of a generous power output and a maximum torque of more than 80 Nm, the motor operates in virtual silence. The modular motor design and integrated controller makes disassembly easier and improve service responsiveness.

Motor v strede neustále prenáša relevantné informácie pri frekvencii až 80 kHz prostredníctvom snímača krútiaceho momentu a dvoch veľmi citlivých snímačov rýchlosti. Prenos výsledných údajov o krútiacom momente kľuky, rýchlosti bicykla a rýchlosti otáčania pedálov do riadiacej jednotky zaisťuje presnú kontrolu bicykla pri dosiahnutí najvyššej možnej účinnosti. Systém Max Drive dáva jazdcovi úplnú kontrolu. Napriek veľkému výkonu a maximálnemu krútiacemu momentu viac ako 80 Nm je motor veľmi tichý. Konštrukcia motora a integrovaný ovládač uľahčujú demontáž a urýchľujú servis.

A high-contrast LCD display delivers all important information at a glance and can also be read in direct sunlight without difficulty. The additional output can be individually controlled by five support levels. The user interface is clearly legible and intuitive to use. The HMI is protected against contact and ingress of water and dirt and complies with protection class IP 65.

Vysoko kontrastný LCD displej poskytuje všetky dôležité informácie na prvý pohľad a dá sa bez problémov prečítať aj na priamom slnečnom svetle. Dodatočný výstup je možné individuálne regulovať pomocou piatich úrovní podpory. Používateľské rozhranie je jasne čitateľné a intuitívne. Jednotka je chránená pred kontaktom a vniknutím vody a nečistôt a vyhovuje triede ochrany IP 65.

DISPLAY DP C11.UART

front / rear motor
predný / zadný motor



DISPLAY DP C07.UART

mid motor
stredový motor



DISPLAY DP C171.UART

optional upgrade
možnosť upgrade



Indication Information	Indikačné informácie	C11	C07	C171
Current Speed (km/h)	Aktuálna rýchlosť (km/h)	✓	✓	✓
Maximum Speed (km/h)	Maximálna rýchlosť (km/h)	✓	✓	✓
Average Speed (km/h)	Priemerná rýchlosť (km/h)	✓	✓	✓
Single Duration Trip	Jednorázový výlet ST – trvanie	✓	✗	✗
Single Distance Trip	Jednorazová cesta ST – vzdialenosť	✓	✓	✓
Total Distance	Celková vzdialenosť	✓	✓	✓
Reset S.T. Duration	Resetovanie ST trvanie	✓	✗	✗
Reset S.T. Distance	Resetovanie ST vzdialenosť	✓	✓	✓
Capacity	Kapacita	✓	✓	✓
Error Code Display	Zobrazenie kódu chyby	✓	✓	✓
Walk Boost	Walk Boost	✓	✓	✓
Backlight	Podsvietenie	✓	✓	✓
Light Sensor	Senzor podsvietenia	✗	✓	✓
Bluetooth	Bluetooth	✗	✗	✓
USB Charge	Usb nabíjanie	✗	✗	✓
USB Communication	USB komunikácia	✗	✗	✓



CONNECT WITH BAFANG GO APP PERFECT CONNECTIVITY

The new smart watch and smartphone app offers users of **Bluetooth-enabled** Bafang-powered eBikes a powerful interface to access ride and fitness data, as well as bike configuration and maintenance functions. BAFANG GO for iOS™ and Android™. Available with Display C171.UART.

APLIKÁCIA BAFANG GO AJ PRE APPLE WATCH

Nová aplikácia pre inteligentné hodinky a smartfóny ponúka používateľom elektrobicyklov s motormi Bafang, s **funkciou Bluetooth** výkonné rozhranie na prístup k údajom o jazde a fitness, ako aj o konfigurácii a údržbe bicyklov. BAFANG GO pre iOS™ a Android™. Dostupné s displejom DP 171.UART.



E-X

A QUIET POWERFUL MOTOR AND A SEMI-INTEGRATED BATTERY ENSURE CYCLING PLEASURE THAT GOES AN EXTRA MILE.

TICHÝ A VÝKONNÝ MOTOR V SPOJENÍ S POLO-INTEGROVANOU BATÉRIOU ZAJISTIA POCIT RADOSTI Z JAZDY NA BICYKLI.

E-CROSS



601-1385



E-XONIC CROSS RM



RÁM/FRAME: Kenzel Aluminium
VEĽKOSŤ/SIZE: MEN: 48/51/56 cm WOMEN: 42/46 cm
VEĽKOSŤ KOLIES/WHEEL SIZE: 28"
VIDLICA/FORK: SR SUNTOUR NEX-D LO
PREDNÝ NÁBOJ/FRONT HUB: Formula DC1420
ZADNÝ NÁBOJ/FREEHUB: Motor (drive unit)
RADENIE/SHIFTERS: Shimano Altus SL-M315 3x8spd
PREHADZOVAČ/REAR DERAILLEUR: Shimano Acera RD-M360SGS
PREŠMÝKAČ/FRONT DERAILLEUR: Shimano Altus FD-M313

REŤAZ/CHAIN: Shimano CN-HG40 8spd
PREVODNÍK S KLUKAMI/CRANK SET: Prowheel TY-CM99 48/38/28T
KAZETA/FREEWHEEL: Shimano CS-HG200 12-32T 8spd
BRZDY/BRAKES: Shimano BR-M375 mechanical disc
MOTOR: Bafang rear electric engine 250W, 36V
BATÉRIA/BATTERY: semi-integrated Lion 16Ah/36V
DISPLEJ/DISPLAY: LCD - current/average
RÁFIKY/RIMS: RMK ZION Color

ONIC E-CROSS

BAFANG

E-xonic is powered by a 250W rear hub electric engine and a 16 Ah battery with LG cells, which is partly integrated into the frame. You can ride with this model up to 120km per charge. The distance depends on the track profile, rider's weight and assistance usage. The driving comfort is enhanced by a lockable suspension fork, mechanical disc brakes and a Shimano Altus 3x8 speed-controlled derailleurs. All the information are shown on LCD display where many functions can be choosed. Upgrade your LCD display to C171 to get connected with BAFANG GO App.

E-xonic s hliníkovým rámom je poháňaný 250 W elektrickým motorom v zadnom náboji a 576 Wh batériou s článkami LG, ktorá je čiastočne integrovaná do rámu. S týmto modelom môžete jazdiť až 120 km na jedno nabitie. Vzdialenosť závisí od profilu trasy, hmotnosti jazdca a použitia asistencie. Komfort pri jazde zvyšuje uzamykateľná odpružená vidlica, mechanické kotúčové brzdy a prehadzovačka Shimano Altus 3x8. Všetky informácie sa zobrazujú na LCD displeji, kde je možné prepínať medzi funkciami. Požiadajte o upgrade displeja na C171 a spojte sa s BAFANG GO App pre smart úžitok.



REAR DRIVE



45 Nm



16 Ah



max. 25 km/h



do 120 km



23,5 kg



715-1387



BAFANG REAR HUB MOTOR

Bafang's reliable rear hub motor provide the torque and weight distribution required for a smooth ride.

VYSOKO VÝKONNÝ ZADNÝ MOTOR

Spôhlivý motor poskytuje rozloženie krútiaceho momentu a hmotnosti potrebného pre plynulú jazdu.



GREENWAY BATTERY

Greenway Battery combines impressive mileage performance, a long lifetime and low weight with an ergonomic design and simple handling.

BATÉRIA GREENWAY

kombinuje pôsobivý kilometrový výkon, dlhú životnosť a nízku hmotnosť s ergonomickým dizajnom a jednoduchou manipuláciou.



EASY-TO-USE HMI C11 UNIT

Versatile
Easy to read

C11 - JEDNODUCHÁ JEDNOTKA

Všestrané
Ľahko čitateľné



SUSPENSION FORK

63mm travel suspension fork offer greater control over varying terrain and include a full lockout system.

ODPRUŽENÁ VIDLICA

Vidlica s odpružením 63 mm ponúka väčšiu kontrolu nad meniacim sa terénom, s funkciou „lock out“.

E-CROSS



MID DRIVE



80 Nm



17,5 Ah



max. 25 km/h



do 160 km



23,5 kg

601-1385



E-XONIC CROSS MM



RÁM/FRAME: Kenzel Aluminium	PREVODNÍK S KLUKAMI/CRANK SET: Aluminium 44T 170mm
VELKOSŤ/SIZE: MEN: 48/51/56 cm WOMEN: 42/46 cm	KAZETA/FREEWHEEL: Shimano CS-HG400 11-34T 9spd
VELKOSŤ KOLIES/WHEEL SIZE: 28"	BRZDY/BRAKES: Shimano BR-MT200 hydraulic disc
VIDLICA/FORK: SR SUNTOUR NCX-D LO	MOTOR: Bafang MaxDrive middle electric engine 250W, 36V
PREDNÝ NÁBOJ/FRONT HUB: Formula CL1420	BATÉRIA/BATTERY: semi-integrated Lion 17,5Ah/36V
ZADNÝ NÁBOJ/FREEHUB: Formula CL1422	DISPLEJ/DISPLAY: LCD - current/average/
RADENIE/SHIFTERS: Shimano Alivio SL-M4000 9spd	STUPEŇ PODPORY/ASSISTANCE LEVEL: 5 levels
PREHADZOVAČ/REAR DERAILLEUR: Shimano Deore RD-M592SGS	RÁFIKY/RIMS: RMK ZION Color
REŤAZ/CHAIN: Shimano CN-HG53 9spd	



715-1387



BAFANG

Max Drive System



www.bafang-e.com

The mid-drive motor constantly samples relevant information at a frequency of up to 80kHz via a torque sensor and two speed sensors which are all highly sensitive. The resulting data on crank torque, vehicle speed and the speed of rotation of the pedals is made available to the controller, ensuring precise control of the vehicle while achieving the highest possible efficiency. The Max Drive System puts the rider in complete control. In spite of a generous power output and a maximum torque of more than 80 Nm, the motor operates in virtual silence.

Motor v strede neustále prenáša relevantné informácie pri frekvencii až 80 kHz prostredníctvom snímača krútiaceho momentu a dvoch veľmi citlivých snímačov rýchlosti. Prenos výsledných údajov o krútiacom momente kľuky, rýchlosti bicykla a rýchlosti otáčania pedálov do riadiacej jednotky zaisťuje presnú kontrolu bicykla pri dosiahnutí najvyššej možnej účinnosti. Systém Max Drive dáva jazdcovi úplnú kontrolu. Napriek veľkému výkonu a maximálnemu krútiacemu momentu viac ako 80 Nm je motor veľmi tichý. Konštrukcia motora a integrovaný ovládač uľahčujú demontáž a urýchľujú servis.



www.KENZL.sk



WHETHER IT'S A SHORT TRIP OR A LONGER EXCURSION, THE E-XONIC E-BIKES ARE THE IDEAL CHOICE FOR EVERYDAY TASKS.

ČI SA VYBERIETE NA KRÁTKY VÝLET ALEBO NA DLHŠIU TÚRU, EXONIC SÚ VÝBORNOU VOĽBOU PRE KAŽDODENNÉ VÝPRAVY.

ESTOUR



MID DRIVE



80 Nm



17,5 Ah



max. 25 km/h



do 160 km



25,5 kg

609-1386



E-XONIC TOUR MM



RÁM/FRAME: Kenzel Aluminium
VEĽKOSŤ/size: MEN: 48/51/56 cm WOMEN: 42/46 cm
VEĽKOSŤ KOLIES/WHEEL SIZE: 28"
VIDLICA/FORK: SR SUNTOUR NCX-D LO
PREDNÝ NÁBOJ/Front HUB: Formula CL1420
ZADNÝ NÁBOJ/FREEHUB: Formula CL1422
RADENIE/SHIFTERS: Shimano Alivio SL-M4000 9spd
PREHADZOVAČ/REAR DERAILLEUR: Shimano Deore RD-M592SGS
REŤAZ/CHAIN: Shimano CN-HG53 9spd

PREVODNÍK S KLUKAMI/CRANK SET: Aluminium 44T 170mm
KAZETA/FREEWHEEL: Shimano CS-HG400 11-34T 9spd
BRZDY/BRAKES: Shimano BR-MT200 hydraulic disc
MOTOR: Bafang MaxDrive middle electric engine 250W, 36V
BATÉRIA/BATTERY: semi-integrated Lion 17,5Ah/36V
DISPLEJ/DISPLAY: LCD - current/average/
STUPEŇ PODPORY/ASSISTANCE LEVEL: 5 levels
RÁFIKY/RIMS: RMK ZION Color



FULLY-EQUIPPED

PLNE VYBAVENÝ



SPORTIVE AND VERSATILE MACHINE

ŠPORTOVÝ A VŠESTRANNÝ STROJ



ENVIRONMENTLY FRIENDLY

ŠETRIACI ŽIVOTNÉ PROSTREDIE



609-1388



BAFANG MID DRIVE MOTOR

Bafang motor keeps the weight central over the bottom bracket.

BAFANG STREDOVÝ MOTOR

Bafang motor udržuje váhu v strede nad integrovaným stredovým zložením.



DLG BATTERY

Battery combines impressive mileage performance, a long lifetime and low weight with an ergonomic design and simple handling.

DLG BATÉRIE

DLG batérie kombinujú pôsobivý kilometrový výkon, dlhú životnosť a nízku hmotnosť s ergonomickým dizajnom a jednoduchou manipuláciou.



BAFANG GO APP

Upgrade to HMI C171 unit with Bluetooth feature and get connected with your E-Bike.

APLIKÁCIA BAFANG GO

„Upgradni“ na displej C171 s funkciou Bluetooth a spoj sa so svojím elektrobicyklom.



LIGHTS

Lights powered by battery of electro set, operated from display.

OSVETLENIE

Svetlá napájané batériou z elektrického systému bicykla, ovládané z displeja.

E-TOUR



REAR DRIVE



45 Nm



16 Ah



max. 25 km/h



do 120 km



25,5 kg

E-XONIC TOUR RM

609-1386



RÁM/FRAME: Kenzel Aluminium	REŤAZ/CHAIN: Shimano CN-HG40 8spd
VEĽKOSŤ/size: MEN: 48/51/56 cm WOMEN: 42/46 cm	PREVODNÍK S KLUKAMI/CRANK SET: Prowheel TY-CM99 48/38/28T
VEĽKOSŤ KOLIES/WHEEL SIZE: 28"	KAZETA/FREEWHEEL: Shimano CS-HG200 12-32T 8spd
VIDLICA/FORK: SR SUNTOUR NEX-D LO	BRZDY/BRAKES: Shimano BR-M375 mechanical disc
PREDNÝ NÁBOJ/FRONT HUB: Formula DC1420	MOTOR: Bafang rear electric engine 250W, 36V
ZADNÝ NÁBOJ/FREEHUB: Motor (drive unit)	BATÉRIA/BATTERY: semi-integrated Lion 16Ah/36V
RADENIE/SHIFTERS: Shimano Altus SL-M315 3x8spd	DISPLEJ/DISPLAY: LCD - current/average
PREHADZOVAČ/REAR DERAILLEUR: Shimano Acera RD-M360SGS	RÁFIKY/RIMS: RMK ZION Color
PREŠMÝKAČ/FRONT DERAILLEUR: Shimano Altus FD-M313	



609-1388



COMPACT
DYNAMIC
POWERFUL

KOMPAKTNÝ
DYNAMICKÝ
SILNÝ

BAFANG

BAFANG REAR HUB MOTOR WITH A MAXIMUM TORQUE OF UP TO 45 NEWTON METERS. THE RATED POWER OF THE MOTOR IS 250 WATTS. THE REAR DRIVE FEATURES SILENT PERFORMANCE, MORE EFFICIENT ENERGY USE AND THUS A WIDER RANGE FOR A SINGLE CHARGE.

SYSTÉM MÁ NÁBOJOVÝ MOTOR BAFANG ZAPLETENÝ V STREDE ZADNÉHO KOLESA, NAJVYŠŠÍ KRÚTIACI MOMENT DOSAHUJE AŽ NA 45 Nm.

MENOVITÝ VÝKON MOTORA JE DVESTOPÄTDESIAT WATTOV. ZADNÝ POHON SA VYZNAČUJE TICHÝM PREJAVOM, EFEKTÍVNEJŠÍM VYUŽITÍM ENERGIE A TÝM PÁDOM AJ ŠIRŠÍM DOJAZDOVÝM OKRUHOM NA JEDNO NABITIE.



LCD panel where you can choose from five levels of support. Upgrade the LCD display C171 and connect the electric bike with smart devices via the Bluetooth function.

LCD panel, kde si môžete vybrať z piatich stupňov motorovej podpory. Na ovládanie motora slúži multifunkčný LCD displej s možnosťou upgradovania na smart displej C171, ktorý umožňuje spojiť elektrobicykel so smart zariadeniami cez funkciu bluetooth.



A MOBILE PHONE APPLICATION FOR E-BIKES, WHICH IS ONLY ADAPTED TO BAFANG DRIVE SYSTEMS. IT SUPPORTS REAL-TIME ACCESS TO RIDE DATA, REAL-TIME ACCESS TO HUMAN HEALTH DATA SUCH AS HEARTBEAT AND CALORIE DATA, AND ACCESS TO NAVIGATION STEERING AND TRAFFIC TIPS.

BAFANG GO

APLIKÁCIA MOBILNÉHO TELEFÓNU PRE E-BICYKLE PODPORUJE PRÍSTUP K ÚDAJOM O JAZDE V REÁLNO M ČASE, PRÍSTUP K ÚDAJOM O ĽUDSKOM ZDRAVÍ, AKO SÚ ÚDAJE O TEPE A KALÓRIÁCH AKO AJ PRÍSTUP K NAVIGAČNÝM TIPOM.



BAFANG GO APP PERFECT CONNECTIVITY

The new smart watch and smartphone app offers users of Bluetooth-enabled Bafang-powered eBikes a powerful interface to access ride and fitness data, as well as bike configuration and maintenance functions. BAFANG GO for iOS™ and Android™ – right there on your wrist or on your phone.

GO TO GOOGLE PLAY AND APP STORE TO DOWNLOAD

Nová aplikácia inteligentných hodín a smartfónov ponúka používateľom elektrobicyklov so systémom Bafang s podporou Bluetooth výkonné rozhranie na prístup k údajom o jazde a fitness, ako aj na konfiguráciu a údržbu bicyklov. BAFANG GO pre iOS™ a Android™ - priamo na zápästí alebo na telefóne.

STIAHNITE CEZ GOOGLE PLAY A APP STORE

BESST

BAFANG E-MOBILITY SALES & SERVICE TOOL BAFANG E-MOBILITY SERVISNÉ ZARIADENIE FOR KENZEL E-BIKES' DEALERS

If you are a dealer of our e-bikes equipped with BAFANG engines and interested to the usage of BESST, then please download software, and contact us to get the permission to BESST.

Ak ste predajcom našich elektrických bicyklov vybavených motormi BAFANG a zaujímate sa o používanie systému BESST, stiahnite si softvér BESST, zadovážte si zariadenie BESST TOOL a kontaktujte nás, aby sme Vám vytvorili užívateľské konto v systéme BESST.



BESST



603 001 BESST tool**

**pri odbere nad 100ks elektrobicyklov zdarma

E-RETRO



Retro style
meets
innovation

NEKUTOČNÁ ENERGIA A ATMOSFÉRA JEDINEČNÉHO ZÁŽITKU

RetroGO & VintiGO v sebe kombinujú pokrokové technológie a moderný dizajn. Motor napomáha, aby sa pedálovalo rýchlejšie a stabilná geometria sa postará o komfortnú jazdu. Elegantný vzhľad okrem držania sa v tónoch jednej farby prináša i využitie prémiovej imitácie kože na sedle a rukovätiach.

TIMELESS DESIGN, FAST,
ELEGANT AND BUILT TO
LAST. EXPERIENCE MORE
RETRO POWER WITH
ELECTRIC DRIVE TECH-
NOLOGY. WELCOME TO
THE RIDE OF YOUR LIFE.



FRONT MOTOR

Small in size, light in weight, high in efficiency, and smooth & quiet in running, this motor is suitable for city bikes.

PREDNÝ MOTOR

Tento motor je vhodný pre mestské bicykle, má malú veľkosť, nízku hmotnosť, vysokú účinnosť a plynulý a tichý chod.



BATTERY

Battery combines impressive mileage performance, a long lifetime and low weight with an ergonomic design and simple handling.

BATÉRIA

Batéria kombinuje pôsobivý kilometrový výkon, dlhú životnosť a nízku hmotnosť s ergonomickým dizajnom a jednoduchou manipuláciou.



EASY-TO-USE HMI C11 UNIT

Versatile
Easy to read

C11 - JEDNODUCHÁ JEDNOTKA

Všestranné
Ľahko čitateľné



FRONT DRIVE



30 Nm



10,4 Ah



max. 25 km/h



do 80 km



23,5 kg



503-1390



VINTIGO 7SPD



6061Al



RÁM/FRAME: Kenzel Aluminium

VEĽKOSŤ/SIZE: 49cm

VEĽKOSŤ KOLIES/WHEEL SIZE: 28"

VIDLICA/FORK: Kenzel Hi-ten

PREDNÝ NÁBOJ/FRONT HUB: Motor (drive unit)

ZADNÝ NÁBOJ/FREEHUB: Shimano Nexus 7spd

BRZDY/BRAKES: Saccon V-brake

MOTOR: front electric engine 250W, 36V

BATÉRIA/BATTERY: Li-ion 10,4Ah, 500 charging cycles

DISPLEJ/DISPLAY: LCD - current/average

STUPEŇ PODPORY/ASSISTANCE LEVEL: 5 levels

RÁFIKY/RIMS: RMK SOA Color GBS

BAFANG



914-1389





MID DRIVE



60 Nm



11,6 Ah



max. 25 km/h



do 125 km



24 kg

501-1394



RETROGO 7SPD



RÁM/FRAME: Kenzel Aluminium

VELKOSTĚ/size: 49cm

VELKOSTĚ KOLIES/WHEEL SIZE: 28"

VIDLICA/FORK: Kenzel Hi-ten

PREDNÝ NÁBOJ/FRONT HUB: Aluminium

ZADNÝ NÁBOJ/FREEHUB: Shimano Nexus 7spd

BRZDY/BRAKES: Shimano BR-T4000

MOTOR: Shimano Steps middle electric engine 250W, 36V

BATÉRIA/BATTERY: Li-ion 11,6Ah, 1000 charging cycles

DISPLEJ/DISPLAY: LCD - current/average

STUPEŇ PODPORY/ASSISTANCE LEVEL: 3 levels

RÁFIKY/RIMS: RMK SOA Color GBS

SHIMANO
STEPS

STYLE

OVER

SPEED





FRONT DRIVE



30 Nm



10,4 Ah



max. 25 km/h



do 80 km



22 kg



E-CITY

503-1531



E-DREAM CLASSIC 3SPD

28" 26" 6061AL6 LS EDO

RÁM/FRAME: Kenzel Aluminium	BRZDY/BRAKES: Saccon V-brake / coaster brake
VIDLIČKA/FORK: Kenzel Hi-ten	MOTOR: front electric engine 250W, 36V, max 25km/h
VEĽKOSŤ/SIZE: 46cm	BATÉRIA/BATTERY: Li-ion 10,4Ah, 500 charging cycles
VEĽKOSŤ KOLIES/WHEEL SIZE: 28" / 26"	DISPLEJ/DISPLAY: LCD - current/average
PREDNÝ NÁBOJ/FRONT HUB: Motor (drive unit)	STUPEŇ PODPORY/ASSISTANCE LEVEL: 5 levels
ZADNÝ NÁBOJ/FREEHUB: Shimano Nexus 3spd	RÁFIKY/RIMS: RMK SOA Color GBS

ALWAYS MOBILE

EXPLORE THE CITY QUICKLY AND COMFORTABLY

SIMPLY EASY

MODERN E-CITY BIKES ARE INTUITIVE TO USE

BAFANG

MORE SAFETY

SUPER-FAST IN REACTION AND ASSIST IN PERFECT HARMONY WITH YOUR INPUTS



511-1531



533-1531



The background features a diagonal split between black and white. A horizontal grey band crosses the center, containing the word 'ROAD'. Below this band, a series of parallel red diagonal lines create a textured effect, extending across the width of the page.

ROAD

RULE THE ROAD



 **kenzel**[®]
bikemakers since 1991

- ✓ LIGHTER
- ✓ FASTER
- ✓ MORE EFFICIENT
- ✓ BETTER EXPERIENCE



601-0011



ATTRACT



RÁM/FRAME: Kenzel Road K-triple light Aluminium

VEĽKOSŤ RÁMU/FRAME SIZE: 54/56/58cm

VIDLICA/FORK: Road 3K carbon tapered

PREDNÉ KOLESO/FRONT WHEEL: Remerx Rapid

ZADNÉ KOLESO/REAR WHEEL: Remerx Rapid

RADENIE/SHIFTERS: Shimano 105 ST-R7000 2x11spd

PREHADZOVAČ/REAR DERAILLEUR: Shimano 105 ST-R7000-SS

PREŠMÝKAČ/FRONT DERAILLEUR: Shimano 105 ST-R7000

REŤAZ/CHAIN: Shimano CN-HG601

KLUKY/CRANK SET: Shimano 105 FC-7000 50/34T

KAZETA/FREEWHEEL: Shimano 105 CS-R7000 11-30T 11spd

BRZDY/BRAKES: Shimano 105 BR-R7000



501-0012



ATTRACT

Pretekársky stroj prináša špičkové spracovanie trojnásobne stenšeného duralového rámu s ultraláhkou karbonovou vydlicou, ktoré spolu úspešne vytvárajú vysokú pevnosť, nízku hmotnosť, vyššiu rýchlosť a lepšie jazdné vlastnosti. Spoločlivý výkon zabezpečuje Shimano 105, ktorý dáva jazdcovi pocit spokojnosti po každodennom tréningu.

Racing machine brings you the top-quality processing of the triple butted alloy frame with ultra-light carbon fork which together successfully create low weight, higher speed and better handling characteristics. Reliable performance is provided by the Shimano 105, which gives the rider a sense of satisfaction after everyday training.



LONG DURABILITY.

EFFICIENT 11-SPEED CASSETTES SPROCKET



RIDER TUNED WIDE RANGE GEARING STAY IN RHYTHM WITH THE CADENCE CONTROL OF 11-SPEED



601-1124



INFINITY *AERO SL 500*



RÁM/FRAME: Kenzel Road K-light aluminium	PREŠMÝKAČ/FRONT DERAILLEUR: Shimano Sora FD-R3000
VEĽKOSŤ RÁMU/FRAME SIZE: 52/54/56/58cm	REŤAZ/CHAIN: Shimano CN-HG53
VIDLICA/FORK: Road aluminium tapered	KĽUKY/CRANK SET: Shimano Sora FC-R3000 50/34T
PREDNÝ NÁBOJ/FRONT HUB: Shimano Sora HB-R3000	KAZETA/FREEWHEEL: Shimano Sora CS-HG50 12-25T 9spd
ZADNÝ NÁBOJ/FREEHUB: Shimano Sora FH-R3000	BRZDY/BRAKES: Shimano Sora BR-3500
RADENIE/SHIFTERS: Shimano Sora ST-R3000 2x9spd	RÁFIKY/RIMS: RMX RCX Black GBS
PREHADZOVAČ/REAR DERAILLEUR: Shimano Sora RD-R3000SS	

RACING GEOMETRIES
DESIGNED TO
MAXIMIZE
PERFORMANCES.





601-1124



INFINITY AERO SL 400



RÁM/FRAME: Kenzel Road K-light aluminium	PREHADZOVAČ/REAR DERAILLEUR: Shimano Tourney RD-A070
VEĽKOSŤ/SIZE: 52/54/56/58cm	PREŠMÝKAČ/FRONT DERAILLEUR: Shimano Tourney FD-A070
VIDLICA/FORK: Road aluminium tapered	REŤAZ/CHAIN: KMC Z7
PREDNÝ NÁBOJ/FRONT HUB: Aluminium	PREVODNÍK S KLUKAMI/CRANK SET: Shimano Tourney FC-A070 50/34T
ZADNÝ NÁBOJ/FREEHUB: Aluminium	KAZETA/FREEWHEEL: Shimano CS-HG200 12-28T 7spd
RADENIE/SHIFTERS: Shimano Tourney ST-A070 2x7spd	RÁFIKY/RIMS: RMX RCX Black GBS

Infinity Aero SL combines the uniqueness of uncompromising aerodynamics and high-power transmission efficiency. This bike has everything that a modern dural bike should have. The frame has clearly defined lines with a sensibly curved upper frame tube. It's got enough racing power to get a startup number, but it's not so focused that the newcomer could not enjoy it. In the key areas of comfort, the pipes are subtle. Thin back struts as well as 31.6 mm seat tube promise compliancy. Stiffness is growing towards the head tube with massive 1.5-inch bearing at the bottom. The colour will please both extravagant and conservatives. The bonus is an excellent equipment and a clear behavior on the road.

Infinity Aero SL v sebe spája aerodynamiku, nízku hmotnosť a vysokú efektivitu prenosu sily. Na ráme nájdete všetko, čo by mal moderný cestný bicykel mať. Má jasne definované línie so zmyselne prehnutou hornou rámovou rúrkou. Má dostatočne pretekársky charakter na to, aby ste naňho pripli štartovacie číslo no nie je tak úzko zameraný, aby si ho nováčik nedokázal vychutnať. V oblastiach kľúčových pre komfort sú rúčky subtilné. Tenké vzpery zadnej stavby aj 31,6 mm sedlovka sľubujú poddajnosť. Tuhosť narastá aj smerom k hlavovke, ktorá má v spodnej časti masívne 1,5-palcové ložisko. Kabeláž je vedená výsostne vnútrom. V každom bode stretávania rúrok sú zvary pekne zahladené. Farebné prevedenie poteší extravagantných aj konzervatívco. Bonusom je vynikajúca výbava a vycibrené správanie na ceste.

EVERYTHING'S
BLURRY
BUT THE
FEELINGS ARE REAL



601-1115



CALIBRE 400



RÁM/FRAME: Kenzel Road K-light Aluminium	PREŠMÝKAČ/FRONT DERAILLEUR: Shimano Tourney FD-A070
VELKOSŤ RÁMU/FRAME SIZE: 52/54/56/58cm	REŤAZ/CHAIN: KMC Z7
VIDLICA/FORK: Road Aluminium tapered	KĽUKY /CRANK SET: Shimano Tourney FC-A070 50/34T
PREDNÝ NÁBOJ/FRONT HUB: Aluminium	KAZETA/FREEWHEEL: Shimano Tourney CS-HG200-7 12-28T
ZADNÝ NÁBOJ/FREEHUB: Aluminium	RÁFIKY/RIMS: RMX RCX Black GBS
RADENIE/SHIFTERS: Shimano Tourney ST-A070 2x7spd	
PREHADZOVAČ/REAR DERAILLEUR: Shimano Tourney RD-A070	



ROAD CYCLING IS PASSION.
CALIBRE BRINGS FULL
 ENJOYMENT TO THE RIDER
 WITH A GUARANTEE
 OF RELIABLE PERFORMANCE.



**RACING
GEOMETRIES
DESIGNED TO
MAXIMIZE
PERFORMANCES**

CALIBRE 400



601-1117







MOUNTAIN BIKE

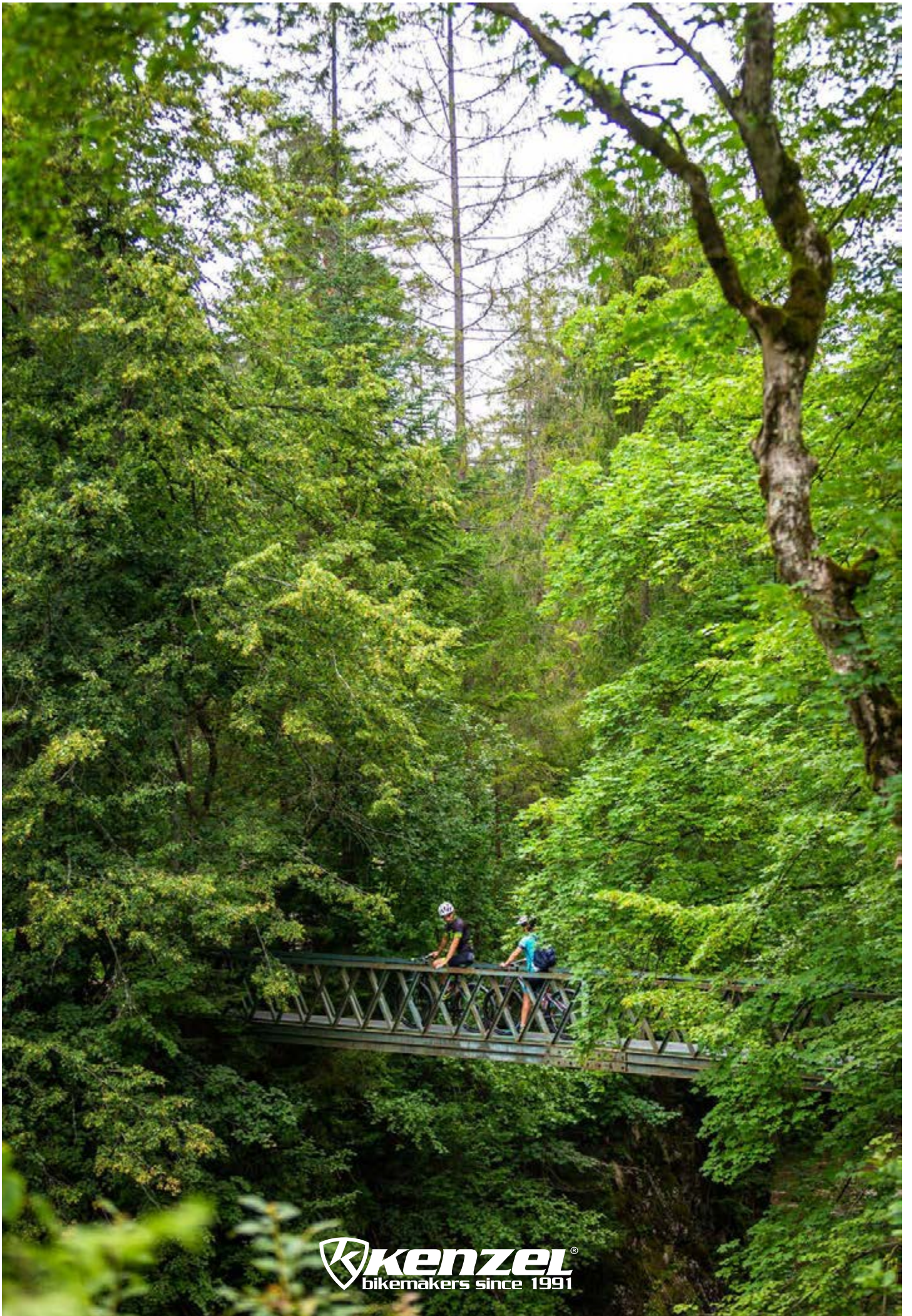

 **kenzel**[®]
bikemakers since 1991

	ENTRY LEVEL	ADVENTURE	SPORT	
	PRE ZAČIATOČNÍKA	REKREAČNÉ	ŠPORTOVÉ	
26"		COMPACT RF		
		PRIME DX50 RF		
		PRIME DX80 SF		
		AVOX SF		
		ROXIS SF		
		AXEL SF		
		SHADE SF		
27.5"		AVOX SF		
		ROXIS SF		
		SHADE SF		
		Q KJU: 100		
		Q KJU: 300		
		Q KJU: 500		
		Q KJU: 700		
29"		Q KJU: 900		
		Q KJU: PRO		
		SHADE SF		
		Q KJU: 100		
		Q KJU: 300		
		Q KJU: 500		
		Q KJU: 700		
	Q KJU: 900			
	Q KJU: PRO			

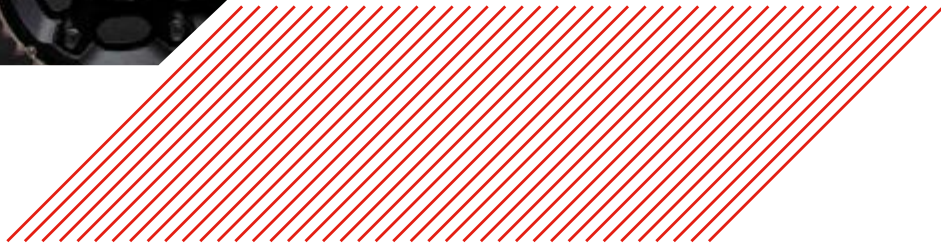

601-1229



Q (KJU:) PRO



RÁM/FRAME: Kenzel MTB Aluminium tripple butted
VEĽKOSŤ RÁMU/FRAME SIZE: 15"/17"/19"/21"/23"
VEĽKOSŤ KOLIES/WHEEL SIZE: 29"/27,5"
VIDLICA/FORK: SR Suntour RAIDON-XC-DS-RL-R-15QLC32
PREDNÝ NÁBOJ/FRONT HUB: Shimano HB-M6010
ZADNÝ NÁBOJ/FREEHUB: Shimano Deore FH-M6000
RADENIE/SHIFTERS: Shimano SLX SL-M7000 2x11spd
PREHADZOVAČ/REAR DERAILLEUR: Shimano SLX RD-M7000GS

PREŠMÝKAČ/FRONT DERAILLEUR: Shimano SLX FD-M7025-H
REŤAZ/CHAIN: Shimano CN-HG601 11spd
KLUKY/CRANK SET: Shimano SLX FC-MT600 36/26T
KAZETA/FREEWHEEL: Shimano SLX CS-M7000 11-42T 11spd
BRZDY/BRAKES: Shimano Acera BL-MT401 hydraulic disc
RÁFIKY/RIMS: RMK ZION Color
HMOTNOSŤ/WEIGHT: 13,3 kg





656-1231



Q (KJU:) 900



RÁM/FRAME: Kenzel MTB Aluminium tripple butted	PREŠMÝKAČ/FRONT DERAILLEUR: Shimano Deore FD-M6025-L
VEĽKOSŤ RÁMU/FRAME SIZE: 15"/17"/19"/21"/23"	REŤAZ/CHAIN: Shimano CN-HG54 10spd
VEĽKOSŤ KOLIES/WHEEL SIZE: 29"/27,5"	KLUKY/CRANK SET: Shimano Deore FC-MT500-2 36/26T
VIDLICA/FORK: SR SUNTOUR XCR Air LO-R	KAZETA/FREEWHEEL: Shimano CS-HG50-10 11-36T 10spd
PREDNÝ NÁBOJ/FRONT HUB: Shimano HB-M6010	BRZDY/BRAKES: Shimano Acera BL-MT401 hydraulic disc
ZADNÝ NÁBOJ/FREEHUB: Shimano Deore FH-M6000	RÁFIKY/RIMS: RMK ZION Color
RADENIE/SHIFTERS: Shimano Deore SL-M6000 2x10spd	HMOTNOSŤ/WEIGHT: 13,6 kg
PREHADZOVAČ/REAR DERAILLEUR: Shimano SLX RD-M7000 SGS	



601-1229



PLAYFUL, AGILE AND
ULTRA CAPABLE, THE
KJU: SERIES DELIVER
PURE FUN ON PRETTY
MUCH ANYTHING THE
MOUNTAIN THROWS
YOUR WAY



601-1230



Q (KJU:) 700



RÁM/FRAME: Kenzel MTB Aluminium tripple butted	PREŠMÝKAČ/FRONT DERAILLEUR: Shimano Deore FD-M6025-L
VELKOSŤ RÁMU/FRAME SIZE: 15"/17"/19"/21"/23"	REŤAZ/CHAIN: Shimano CN-HG54 10spd
VELKOSŤ KOLIES/WHEEL SIZE: 29"/27,5"	PREVODNÍK S KĽUKAMI/CRANK SET: Shimano Deore FC-MT500 36-26T
VIDLICA/FORK: SR Suntour XCR Air LO-R	KAZETA/FREEWHEEL: Shimano CS-HG50 11-36T 10spd
PREDNÝ NÁBOJ/FRONT HUB: Formula CL1420 Disc	BRZDY/BRAKES: Shimano Altus BL-MT200 hydraulic disc
ZADNÝ NÁBOJ/FREEHUB: Formula CL1422 Disc	RÁFIKY/RIMS: RMK ZION Color
RADENIE/SHIFTERS: Shimano Deore SL-M6000-L 2x10spd	HMOTNOSŤ/WEIGHT: 13,7 kg
PREHADZOVAČ/REAR DERAILLEUR: Shimano Deore RD-M6000	

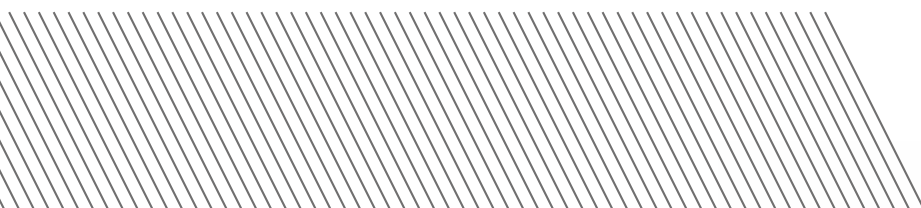

609-1228





609-1228



657-1231



Q (KJU:) 500



RÁM/FRAME: Kenzel MTB Aluminium tripple butted
VEĽKOSŤ RÁMU/FRAME SIZE: MEN: 15"/17"/19"/21"/23" WOMEN: 16"/18"
VEĽKOSŤ KOLIES/WHEEL SIZE: 29"/27,5"
VIDLICA/FORK: SR Suntour XCR Air LO-R
PREDNÝ NÁBOJ/FRONT HUB: Formula CL1420 Disc
ZADNÝ NÁBOJ/FREEHUB: Formula CL1422 Disc
RADENIE/SHIFTERS: Shimano Acera SL-M3010 2x9spd
PREHADZOVAČ/REAR DERAILLEUR: Shimano Deore RD-M592

PREŠMÝKAČ/FRONT DERAILLEUR: Shimano FDM2020-TS
REŤAZ/CHAIN: KMC X9 112L
PREVODNÍK S KLUKAMI/CRANK SET: Shimano Altus FC-MT210-2 11-36T 9spd
KAZETA/FREEWHEEL: Shimano CS-HG400
BRZDY/BRAKES: Shimano Altus BL-MT200 Hydraulic Disc
RÁFIKY/RIMS: RMK ZION Color
HMOTNOSŤ/WEIGHT: 13,8 kg



601-1247



29" 27.5"

A SELECTION OF COMPONENTS PERFECTLY ADAPTED TO THE FEMALE BODY SHAPE, SO AS TO OPTIMIZE BOTH WELL-BEING AND ERGONOMICS.

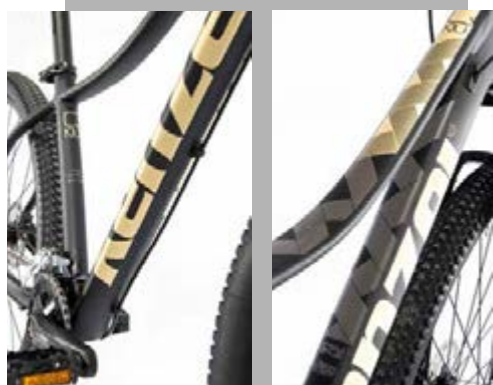



502-1247

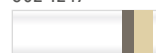

656-1231



Q (KJU:) 300



RÁM/FRAME: Kenzel MTB Aluminium tripple butted

VELKOSTĚ RÁMU/FRAME SIZE: MEN: 15"/17"/19"/21"/23" WOMEN: 16"/18"

VELKOSTĚ KOLÍES/WHEEL SIZE: 29"/27,5"

VIDLICA/FORK: SR Suntour XCR-32 LO

PREDNÝ NÁBOJ/FRONT HUB: Formula CL1420 Disc

ZADNÝ NÁBOJ/FREEHUB: Formula CL1422 Disc

RADENIE/SHIFTERS: Shimano Altus SL-M2000 3x9spd

PREHADZOVAČ/REAR DERAILLEUR: Shimano Alivio RD-M4000-GS

PREŠMÝKAČ/FRONT DERAILLEUR: Shimano Acera FD-M3000

REŤAZ/CHAIN: KMC X9 112L

PREVODNÍK S KLUKAMI/CRANK SET: Shimano Altus FC-M2000 40/30/22T

KAZETA/FREEWHEEL: Shimano CS-HG200 11-36T 9spd

BRZDY/BRAKES: Shimano Altus BL-MT200 Hydraulic Disc

RÁFIKY/RIMS: RMK ZION Color

HMOTNOSTĚ/WEIGHT: 14,2 kg



657-1231



601-1248





655-1231

27,5"



601-1230

27,5"



Q (KJU:) 100



RÁM/FRAME: Kenzel MTB Aluminium tripple butted	PREŠMÝKAČ/FRONT DERAILLEUR: Shimano Altus FD-M310
VELKOSŤ RÁMU/FRAME SIZE: MEN: 15"/17"/19"/21"/23" WOMEN: 16"/18"	REŤAZ/CHAIN: KMC Z8 112L
VELKOSŤ KOLIES/WHEEL SIZE: 29"/27,5"	PREVODNÍK S KLUKAMI/CRANK SET: Shimano Tourney FC-TY501 42/34/24T
VIDLICA/FORK: SR Suntour XCM HLO	KAZETA/FREEWHEEL: Shimano CS-HG31 11-34T 8spd
PREDNÝ NÁBOJ/FRONT HUB: Formula CL1420 Disc	BRZDY/BRAKES: Shimano Altus BL-MT200 Hydraulic Disc
ZADNÝ NÁBOJ/FREEHUB: Formula CL1422 Disc	RÁFIKY/RIMS: RMK ZION Color
RADENIE/SHIFTERS: Shimano Altus SL-M315 3x8spd	HMOTNOSŤ/WEIGHT: 14,4 kg
PREHADZOVAČ/REAR DERAILLEUR: Shimano Acera RD-M360-GS	



609-1228



502-1248





SHADE



Take over the mountains





502-1145

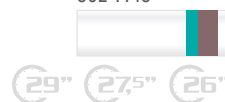

609-1124



SHADE



RÁM/FRAME: Kenzel MTB Aluminium	PREŠMÝKAČ/FRONT DERAILLEUR: Shimano Tourney FD-TY500
VEĽKOSŤ RÁMU/FRAME SIZE: MEN: 17"/19"/21" WOMEN: 16"/18"	REŤAZ/CHAIN: KMC Z7
VEĽKOSŤ KOLIES/WHEEL SIZE: 29"/27,5"/26"	KĽUKY/CRANK SET: Prowheel TA-CM68 42/34/24T
VIDLICA/FORK: SR Suntour XCM-HLO	KAZETA/FREEWHEEL: Shimano MF-TZ500-7 14-28T 7spd
PREDNÝ NÁBOJ/FRONT HUB: Formula DC1420	BRZDY/BRAKES: Zoom DB-280 mechanical disc
ZADNÝ NÁBOJ/FREEHUB: Formula DC31-8	RÁFIKY/RIMS: RMK SOA Color Disc
RADENIE/SHIFTERS: Shimano Altus ST-EF500 3x7spd	HMOTNOSŤ/WEIGHT: 15,5 kg / 14,7 kg / 15,4 kg
PREHADZOVAČ/REAR DERAILLEUR: Shimano Tourney RD-TY300	



656-1138



27,5"



601-1141



29" 27,5" 26"



655-1138



27,5"



601-1126



29"



701-1211



ROXIS SF



RÁM/FRAME: Kenzel MTB Hi-ten	PREŠMÝKAČ/FRONT DERAILLEUR: Shimano FD-TZ500
VEĽKOSŤ RÁMU/FRAME SIZE: 15"	REŤAZ/CHAIN: KMC Z7
VEĽKOSŤ KOLIES/WHEEL SIZE: 27,5"/26"	KĽUKY/CRANK SET: Detai steel 48/38/28T
VIDLICA/FORK: Zoom CH 327E	KAZETA/FREEWHEEL: Shimano MF-TZ500 6spd
PREDNÝ NÁBOJ/FRONT HUB: Aluminium	BRZDY/BRAKES: Saccon V-brake
ZADNÝ NÁBOJ/FREEHUB: Aluminium	RÁFIKY/RIMS: RMK SOA Natural GBS
RADENIE/SHIFTERS: Shimano Tourney SL-RS35 3x6spd	HMOTNOSŤ/WEIGHT: 15 kg
PREHADZOVAČ/REAR DERAILLEUR: Shimano Tourney RD-TZ500	



719-1211



609-1212



556-1216



535-1217



502-1218





535-1224

26"



701-1221

27,5" 26"



AVOX SF

27,5" 26" SF
Suspension fork

RÁM/FRAME: Kenzel MTB Hi-ten
VEĽKOSŤ RÁMU/FRAME SIZE: MEN: 17"/19" WOMEN: 15"
VEĽKOSŤ KOLIES/WHEEL SIZE: 27,5"/26"
VIDLICA/FORK: Zoom CH 327E
PREDNÝ NÁBOJ/FRONT HUB: Aluminium
ZADNÝ NÁBOJ/FREEHUB: Aluminium
RADENIE/SHIFTERS: Shimano Tourney SL-RS35 3x6spd
PREHADZOVAČ/REAR DERAILLEUR: Shimano Tourney RD-TZ500

PREŠMÝKAČ/FRONT DERAILLEUR: Shimano FD-TZ500
REŤAZ/CHAIN: KMC Z7
KLUKY/CRANK SET: Detai steel 48/38/28T
KAZETA/FREEWHEEL: Shimano MF-TZ500 6spd
BRZDY/BRAKES: Saccon V-brake
RÁFIKY/RIMS: RMK SOA Natural GBS
HMOTNOSŤ/WEIGHT: 16,6 kg



747-1227



26"



509-1222



26"



502-1225



27,5" 26"



535-1172



601-1169



PRIME DX80 SF26



RÁM/FRAME: Kenzel MTB Hi-ten

VELKOST' RÁMU/FRAME SIZE: MEN: 19" WOMEN: 17"

VELKOST' KOLIES/WHEEL SIZE: 26"

VIDLICA/FORK: Zoom CH 327E

PREDNÝ NÁBOJ/FRONT HUB: Aluminium

ZADNÝ NÁBOJ/FREEHUB: Aluminium

RADENIE/SHIFTERS: Shimano Tourney SL-RS35 3x6spd

PREHADZOVAČ/REAR DERAILLEUR: Shimano Tourney RD-TZ500

PREŠMÝKAČ/FRONT DERAILLEUR: Shimano FD-TZ500

REŤAZ/CHAIN: KMC Z7

KĽUKY/CRANK SET: Detai steel 48/38/28T

KAZETA/FREEWHEEL: Shimano MF-TZ500 6spd

BRZDY/BRAKES: Saccon V-brake

RÁFIKY/RIMS: RMK SOA Natural GBS

HMOTNOSŤ/WEIGHT: 15,4 kg



509-1180



701-1168



502-1173

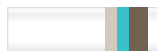



502-1173



509-1180



PRIME DX50 RF26



RÁM/FRAME: Kenzel MTB Hi-ten	PREŠMÝKAČ/FRONT DERAILLEUR: Shimano FD-TZ500
VEĽKOSŤ RÁMU/FRAME SIZE: MEN: 19" WOMEN: 17"	REŤAZ/CHAIN: KMC Z7
VEĽKOSŤ KOLIES/WHEEL SIZE: 26"	KLUKY/CRANK SET: Detai steel 48/38/28T
VIDLICA/FORK: Kenzel Hi-ten	KAZETA/FREEWHEEL: Shimano MF-TZ500 6spd
PREDNÝ NÁBOJ/FRONT HUB: Aluminium	BRZDY/BRAKES: Saccon V-brake
ZADNÝ NÁBOJ/FREEHUB: Aluminium	RÁFIKY/RIMS: RMK SOA Natural GBS
RADENIE/SHIFTERS: Shimano Tourney SL-RS35 3x6spd	HMOTNOSŤ/WEIGHT: 14,8 kg
PREHADZOVAČ/REAR DERAILLEUR: Shimano Tourney RD-TZ500	



601-1169



535-1172





719-1235



AXEL SF26



RÁM/FRAME: MTB full suspension Hi-ten

VELKOST' RÁMU/FRAME SIZE: 18"

VELKOST' KOLIES/WHEEL SIZE: 26"

VIDLICA/FORK: Zoom CH 327E

PREDNÝ NÁBOJ/FRONT HUB: Hi-ten

ZADNÝ NÁBOJ/FREEHUB: Hi-ten

RADENIE/SHIFTERS: Shimano Tourney SL-RS35 3x6spd

PREHADZOVAČ/REAR DERAILLEUR: Shimano Tourney RD-TZ500

PREŠMÝKAČ/FRONT DERAILLEUR: Shimano FD-TZ500

REŤAZ/CHAIN: KMC Z7

KĽUKY/CRANK SET: Detai steel 48/38/28T

KAZETA/FREEWHEEL: Shimano MF-TZ500 6spd

BRZDY/BRAKES: Saccon V-brake

RÁFIKY/RIMS: RMK SOA Natural GBS

HMOTNOSŤ/WEIGHT: 17,1 kg



547/501-1235



701/525-1235





514-1187



533-1269



519-1184



COMPACT RF26



RÁM/FRAME: Kenzel MTB Hi-ten	PREŠMÝKAČ/FRONT DERAILLEUR: Gilong QLD-03
VEĽKOSŤ RÁMU/FRAME SIZE: MEN: 19" WOMEN: 17"	REŤAZ/CHAIN: KMC Z6
VEĽKOSŤ KOLIES/WHEEL SIZE: 26"	KLUKY/CRANK SET: Detai steel 48/38/28T
VIDLICA/FORK: Kenzel Hi-ten	KAZETA/FREEWHEEL: QLF-06 6spd
PREDNÝ NÁBOJ/FRONT HUB: Hi-ten	BRZDY/BRAKES: Saccon V-brake
ZADNÝ NÁBOJ/FREEHUB: Hi-ten	RÁFIKY/RIMS: RMK REA Natural
RADENIE/SHIFTERS: Gilong QLK-01	HMOTNOSŤ/WEIGHT: 14,4 kg
PREHADZOVAČ/REAR DERAILLEUR: Gilong QLB-04	



601-1184



747-1188



502-1198

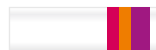

535-1200



ALL TERRAIN



 **kenzel**[®]
bikemakers since 1991

CROSS

KROSOVÉ

SÉRIA ALL-TERRAIN BIKE SA ZAMERIAVA NA ZDRAVÝ ŽIVOTNÝ ŠTÝL A JAZDCOV, PRE KTORÝCH POTEŠENIE Z JAZDY A DLHÁ ŽIVOTNOSŤ BICYKLA PREVAŽUJE NAD MNOŽSTVOM FUNKCIÍ NA BICYKLI. ČI UŽ HO VYUŽÍVATE NA DENNÉ DOCHÁDZANIE DO PRÁCE, VÍKENDOVÉ VÝLETY ALEBO DLHÚ CYKLODOVOLENKU.

ALL-TERRAIN BIKE RANGE IS DESIGNED FOR THE LIFESTYLE RIDER WHO VALUES PLEASURE OF SPEED AND DURABILITY OVER ADVANCED FEATURES. WHETHER IT'S YOUR DAILY COMMUTE, A WEEKEND JAUNT OR A LONG CYCLING HOLIDAY, THESE VERSATILE PRODUCTS DELIVER THE COMFORT AND FUNCTIONALITY.



ADVENTURE		SPORT	
REKREAČNÉ		ŠPORTOVÉ	
CROSS / KROSOVÉ			
28"	STROLLER		
	DISTANCE 200		
	DISTANCE 600		
	DISTANCE 800		
TOURING / TREKKING			
28"	FRESH		
	ARWEN		
	STROLLER		
	DISTANCE 200		
	DISTANCE 400		
DISTANCE 600			

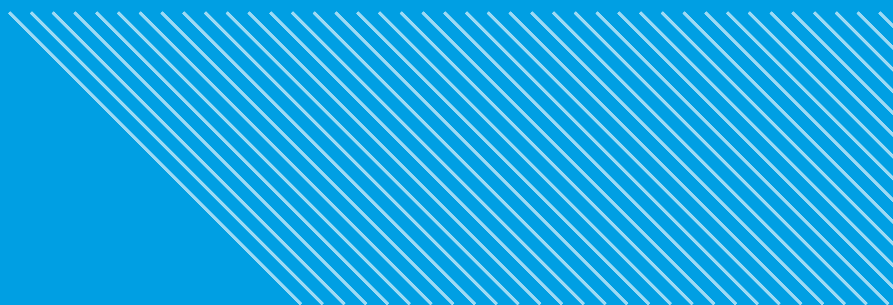



601-1343



609-1345



DISTANCE CR 800



RÁM/FRAME: Kenzel Aluminium
VEĽKOSŤ/size: MEN: 48/51/56 cm WOMEN: 44/48 cm
VEĽKOSŤ KOLIES/WHEEL SIZE: 28"
VIDLICA/FORK: SR SUNTOUR NCX-D RL 700C
PREDNÝ NÁBOJ/Front HUB: Shimano HB-RM35
ZADNÝ NÁBOJ/FREEHUB: Shimano FH-RM35
RADENIE/SHIFTERS: Shimano Deore SL-T6000 3x10spd
PREHADZOVAČ/REAR DERAILLEUR: Shimano Deore T6000SGS

PREŠMÝKAČ/Front DERAILLEUR: Shimano Deore FD-T6000
REŤAZ/CHAIN: Shimano CN-HG54 10spd
PREVODNÍK S KLUKAMI/CRANK SET: Shimano Deore FC-T6010 48/36/26T
KAZETA/FREEWHEEL: Shimano CS-HG500 11-34T 10spd
BRZDY/BRAKES: Shimano Deore BR BR-MT401 hydraulic disc
RÁFIKY/RIMS: RMK Zion Color Disc
HMOTNOSŤ/WEIGHT: 14,1 kg



502-1346





601-1345

DISTANCE CR 600



RÁM/FRAME: Kenzel Aluminium	PREŠMÝKAČ/FRONT DERAILLEUR: Shimano Alivio FD-T4000
VEĽKOSŤ/SIZE: MEN: 48/51/56 cm WOMEN: 44/48 cm	REŤAZ/CHAIN: KMC X9 114L
VEĽKOSŤ KOLIES/WHEEL SIZE: 28"	PREVODNÍK S KLUKAMI/CRANK SET: Shimano Alivio FC-T4010 48/36/26T
VIDLICA/FORK: SR SUNTOUR NCX-D LO 700C	KAZETA/FREEWHEEL: Shimano CS-HG400 11-34T 9spd
PREDNÝ NÁBOJ/FRONT HUB: Shimano HB-RM35	BRZDY/BRAKES: Shimano BR-MT401 hydraulic disc
ZADNÝ NÁBOJ/FREEHUB: Shimano FH-RM35	RÁFIKY/RIMS: RMK Zion Color Disc
RADENIE/SHIFTERS: Shimano Alivio SL-M4000 3x9spd	HMOTNOSŤ/WEIGHT: 14,3 kg
PREHADZOVAČ/REAR DERAILLEUR: Shimano Deore RD-M592SGS	



601-1347



601-1343

DISTANCE CR 400



RÁM/FRAME: Kenzel Aluminium	PREŠMÝKAČ/FRONT DERAILLEUR: Shimano Acera FD-T3000
VEĽKOSŤ/SIZE: MEN: 48/51/56 cm WOMEN: 44/48 cm	REŤAZ/CHAIN: KMC X9 114L
VEĽKOSŤ KOLIES/WHEEL SIZE: 28"	PREVODNÍK S KLUKAMI/CRANK SET: Shimano Acera FC-T3010 48/36/26T
VIDLICA/FORK: SR SUNTOUR NCX-D LO 700C	KAZETA/FREEWHEEL: Shimano CS-HG200-9 11-34T 9spd
PREDNÝ NÁBOJ/FRONT HUB: Formula CL1420 Disc	BRZDY/BRAKES: Shimano BR-MT200 hydraulic disc
ZADNÝ NÁBOJ/FREEHUB: Formula CL1422 Disc	RÁFIKY/RIMS: RMK Zion Color Disc
RADENIE/SHIFTERS: Shimano Acera SL-M3000 3x9spd	HMOTNOSŤ/WEIGHT: 14,7 kg
PREHADZOVAČ/REAR DERAILLEUR: Shimano Alivio RD-M4000SGS	



502-1345



601-1345

609-1345

DISTANCE CR 200



RÁM/FRAME: Kenzel Aluminium

VEĽKOSŤ/SIZE: MEN: 48/51/56 cm WOMEN: 44/48 cm

VEĽKOSŤ KOLIES/WHEEL SIZE: 28"

VIDLICA/FORK: SR SUNTOUR NEX HLO 700C

PREDNÝ NÁBOJ/FRONT HUB: Formula CL1420 disc

ZADNÝ NÁBOJ/FREEHUB: Formula CL1422 disc

RADENIE/SHIFTERS: Shimano Altus SL-M315 3x8spd

PREHADZOVAČ/REAR DERAILLEUR: Shimano Acera RD-M360SGS

PREŠMÝKAČ/FRONT DERAILLEUR: Shimano Tourney FD-TY510

REŤAZ/CHAIN: KMC Z8 114L

PREVODNÍK S KLUKAMI/CRANK SET: Shimano Altus FC-M311 48/38/28T

KAZETA/FREEWHEEL: Shimano CS-HG200-8 12-32T 8spd

BRZDY/BRAKES: Shimano BR-MT200 hydraulic disc

RÁFIKY/RIMS: RMK Zion Color Disc

HMOTNOSŤ/WEIGHT: 15,2 kg



502-1345



601-1347

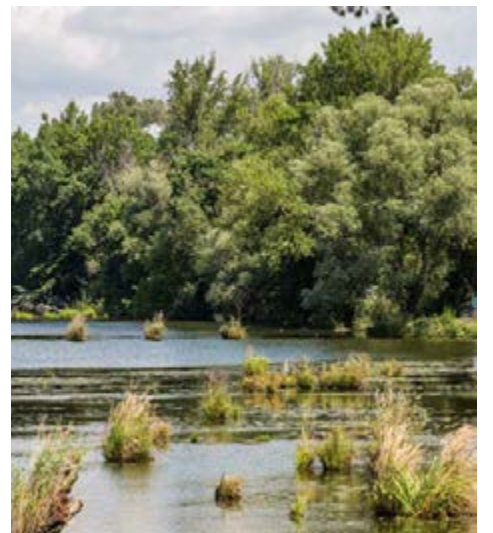



601-1357



609-1358



STROLLER



RÁM/FRAME: Kenzel Aluminium	PREŠMÝKAČ/FRONT DERAILLEUR: Shimano Tourney FD-TY510
VELKOSŤ/size: MEN: 48/51/56 cm WOMEN: 44/48 cm	REŤAZ/CHAIN: KMC Z7
VELKOSŤ KOLIES/WHEEL SIZE: 28"	KLUKY/CRANK SET: Prowheel TY-CM99 48/38/28T
VIDLICA/FORK: SR Suntour M3010 700C	KAZETA/FREEWHEEL: Shimano Tourney MF-TZ500 14-28T 7spd
PREDNÝ NÁBOJ/FRONT HUB: Joy Tech Aluminium	BRZDY/BRAKES: Saccon V-brake
ZADNÝ NÁBOJ/FREEHUB: Joy Tech Aluminium	RÁFIKY/RIMS: RMK SOA Natural GBS
RADENIE/SHIFTERS: Shimano Altus ST-EF500 3x7spd	HMOTNOSŤ/WEIGHT: 14,80 kg
PREHADZOVAČ/REAR DERAILLEUR: Shimano Tourney RD-TY300	



601-1350



502-1358



ALL TERRAIN



 **kenzel**[®]
bikemakers since 1991

A decorative graphic consisting of a series of parallel diagonal lines in a light blue color, extending from the left edge of the page towards the right, partially overlapping the text boxes.

TOURING

TREKKING

SÉRIA ALL-TERRAIN BIKE SA ZAMERIAVA NA ZDRAVÝ ŽIVOTNÝ ŠTÝL A JAZDCOV, PRE KTORÝCH POTEŠENIE Z JAZDY A DLHÁ ŽIVOTNOSŤ BICYKLA PREVAŽUJE NAD MNOŽSTVOM FUNKCIÍ NA BICYKLI. ČI UŽ HO VYUŽÍVATE NA DENNÉ DOCHÁDZANIE DO PRÁCE, VÍKENDOVÉ VÝLETY ALEBO DLHÚ CYKLODOVOLENKU.

ALL-TERRAIN BIKE RANGE IS DESIGNED FOR THE LIFESTYLE RIDER WHO VALUES PLEASURE OF SPEED AND DURABILITY OVER ADVANCED FEATURES. WHETHER IT'S YOUR DAILY COMMUTE, A WEEKEND JAUNT OR A LONG CYCLING HOLIDAY, THESE VERSATILE PRODUCTS DELIVER THE COMFORT AND FUNCTIONALITY.

MODELOVÝ RAD DISTANCE

EXPECT MORE



JE SPOJENÍM VŠESTRANNOSTI
A KAŽDODENNEJ VYUŽITELNOSTI
PRE CYKLISTOV S VYSOKÝMI NÁROKMI



601-1345

DISTANCE TR 600



RÁM/FRAME: Kenzel Aluminium	PREŠMÝKAČ/FRONT DERAILLEUR: Shimano Alivio FD-T4000
VEĽKOSŤ/SIZE: MEN: 48/51/56 cm WOMEN: 44/48 cm	REŤAZ/CHAIN: KMC X9 114L
VEĽKOSŤ KOLIES/WHEEL SIZE: 28"	PREVODNÍK S KLUKAMI/CRANK SET: Shimano Alivio FC-T4010 48/36/26T
VIDLICA/FORK: SR SUNTOUR NCX-D LO 700C	KAZETA/FREEWHEEL: Shimano CS-HG400 11-34T 9spd
PREDNÝ NÁBOJ/FRONT HUB: Shimano HB-RM35	BRZDY/BRAKES: Shimano BR-MT401 hydraulic disc
ZADNÝ NÁBOJ/FREEHUB: Shimano FH-RM35	RÁFIKY/RIMS: RMK Zion Color Disc
RADENIE/SHIFTERS: Shimano Alivio SL-M4000 3x9spd	HMOTNOSŤ/WEIGHT: 16,1 kg
PREHADZOVAČ/REAR DERAILLEUR: Shimano Deore RD-M592SGS	



502-1346



601-1343



DISTANCE TR 400



RÁM/FRAME: Kenzel Aluminium	PREŠMÝKAČ/FRONT DERAILLEUR: Shimano Acera FD-T3000
VEĽKOSŤ/SIZE: MEN: 48/51/56 cm WOMEN: 44/48 cm	REŤAZ/CHAIN: KMC X9 114L
VEĽKOSŤ KOLIES/WHEEL SIZE: 28"	PREVODNÍK S KLUKAMI/CRANK SET: Shimano Acera FC-T3010 48/36/26T
VIDLICA/FORK: SR SUNTOUR NCX-D LO 700C	KAZETA/FREEWHEEL: Shimano CS-HG200 11-34T 9spd
PREDNÝ NÁBOJ/FRONT HUB: Formula CL1420 Disc	BRZDY/BRAKES: Shimano BR-MT200 hydraulic disc
ZADNÝ NÁBOJ/FREEHUB: Formula CL1422 Disc	RÁFIKY/RIMS: RMK Zion Color Disc
RADENIE/SHIFTERS: Shimano Alivio SL-M3000 3x9spd	HMOTNOSŤ/WEIGHT: 16,3 kg
PREHADZOVAČ/REAR DERAILLEUR: Shimano Alivio RD-M4000SGS	



502-1346

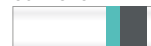



609-1345



601-1345

DISTANCE TR 200



RÁM/FRAME: Kenzel Aluminium	PREŠMÝKAČ/FRONT DERAILLEUR: Shimano Tourney FD-TY510
VELKOSŤ/size: MEN: 48/51/56 cm WOMEN: 44/48 cm	REŤAZ/CHAIN: KMC Z8 114L
VELKOSŤ KOLIES/WHEEL SIZE: 28"	PREVODNÍK S KLUKAMI/CRANK SET: Shimano Altus FC-M311 48/38/28T
VIDLICA/FORK: SR SUNTOUR NEX HLO 700C	KAZETA/FREEWHEEL: Shimano CS-HG200 12-32T 8spd
PREDNÝ NÁBOJ/FRONT HUB: Formula CL1422 Disc	BRZDY/BRAKES: Shimano BR-MT200 hydraulic disc
ZADNÝ NÁBOJ/FREEHUB: Formula CL1422 Disc	RÁFIKY/RIMS: RMK SOA Color GBS
RADENIE/SHIFTERS: Shimano Altus SL-M315 3x8spd	HMOTNOSŤ/WEIGHT: 17,2 kg
PREHADZOVAČ/REAR DERAILLEUR: Shimano Acera RD-M360SGS	



614-1346

601-1350



601-1357



609-1358



601-1359



STROLLER

28" 6061 AL 6061 AL FEB 6061 AL

RÁM/FRAME: Kenzel Aluminium	PREŠMÝKAČ/FRONT DERAILLEUR: Shimano Tourney FD-TY510
VEĽKOSŤ/SIZE: MEN: 48/51/56 cm WOMEN: 44/48 cm	REŤAZ/CHAIN: KMC Z7
VEĽKOSŤ KOLIES/WHEEL SIZE: 28"	KĽUKY/CRANK SET: Prowheel TY-CM99 48/38/28T
VIDLICA/FORK: SR Suntour M3010-AI 700C	KAZETA/FREEWHEEL: Shimano Tourney MF-TZ500 14-28T 7spd
PREDNÝ NÁBOJ/FRONT HUB: Joy Tech Aluminium	BRZDY/BRAKES: Saccon V-brake
ZADNÝ NÁBOJ/FREEHUB: Joy Tech Aluminium	RÁFIKY/RIMS: RMK SOA Natural GBS
RADENIE/SHIFTERS: Shimano Altus ST-EF500 3x7spd	HMOTNOSŤ/WEIGHT: 15,8 kg
PREHADZOVAČ/REAR DERAILLEUR: Shimano Tourney RD-TY300	



514-1358



601-1350



502-1358

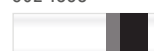



609-1256



601-1257



501-1255



ARWEN

RÁM/FRAME: Kenzel Aluminium	PREŠMÝKAČ/FRONT DERAILLEUR: Shimano Tourney FD-TZ500
VEĽKOSŤ/SIZE: MEN: 48/51/56 cm WOMEN: 44/48 cm	REŤAZ/CHAIN: KMC Z7 6spd
VEĽKOSŤ KOLIES/WHEEL SIZE: 28"	PREVODNÍK S KLUKAMI/CRANK SET: Detai Steel 48/38/28T
VIDLICA/FORK: ZOOM 128 700C	KAZETA/FREEWHEEL: Shimano MF-TZ500 14-28T 6spd
PREDNÝ NÁBOJ/FRONT HUB: Aluminium	BRZDY/BRAKES: Saccon V-brake
ZADNÝ NÁBOJ/FREEHUB: Aluminium	RÁFIKY/RIMS: RMK SOA Natural GBS
RADENIE/SHIFTERS: Shimano SL-RS35 3x6spd	HMOTNOSŤ/WEIGHT: 15,9 kg
PREHADZOVAČ/REAR DERAILLEUR: Shimano Tourney RD-TZ500	



502-1259

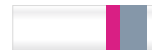

601-1257



614-1258





619-1205



FRESH



RÁM/FRAME: Kenzel Hi-ten

VEĽKOSŤ/size: MEN: 51/56 cm WOMEN: 44 cm

VEĽKOSŤ KOLIES/WHEEL SIZE: 28"

VIDLICA/FORK: Kenzel Hi-ten

PREDNÝ NÁBOJ/FRONT HUB: Aluminium

ZADNÝ NÁBOJ/FREEHUB: Aluminium

RADENIE/SHIFTERS: Shimano Tourney SL-RS35 3x6spd

PREHADZOVAČ/REAR DERAILLEUR: Shimano Tourney RD-TZ500

PREŠMÝKAČ/FRONT DERAILLEUR: Shimano FD-TZ500

REŤAZ/CHAIN: KMC Z7

KĽUKY/CRANK SET: Detai Stel 48/38/28T

KAZETA/FREEWHEEL: Shimano MF-TZ500 6spd

BRZDY/BRAKES: Saccon V-brake

RÁFIKY/RIMS: RMK SOA Natural GBS

HMOTNOSŤ/WEIGHT: 16,5 kg



601-1202



601-1204



601-1203



509-1201





504-1206



FRESH

28"

SIMPLE BIKES FOR ORDINARY NON-ATHLETES WILL PROBABLY NEVER BE ENOUGH. WHETHER YOU'RE GOING A FEW KILOMETERS TO WORK ONCE A WEEK OR JUST SIMPLY RIDE DOWN THE DIKE.

JEDNODUCHÝCH BICYKLOV PRE OBYČAJNÝCH NEŠPORTOVCOV ASI NEBUDE NIKDY DOSŤ. ČI UŽ SA CHYSTÁŠ RAZ DO TÝŽDŇA ZÁJSŤ PÁR KILOMETROV DO PRÁCE ALEBO LEN JEDNODUCHO ZAJAZDIŤ SI PO HRÁDZI.



514-1206



533-1203



502-1208



502-1206

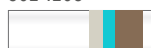

701-1207





Lifestyle





 **kenzel**[®]
bikemakers since 1991

	RETRO	CITY	ADVENTURE	FOLDING	
	RETRO	MESTSKÉ	REKREAČNÉ	SKLADACIE	
20"				ECOPOLIS 6SPD	
				SIMPLYCITY 3SPD	
				CAMPING CLASSIC 3SPD	
				CAMPING CEREMONY 1SPD	
24"		SIT N'GO CEREMONY 1SPD			
		DREAM ROYAL 6SPD			
		DREAM CEREMONY 1SPD			
		MONIKA CEREMONY 1SPD			
		LORETA CEREMONY 1SPD			
		DREAM CLASSIC 3SPD			
		DREAM ROYAL 6SPD			
		DREAM CEREMONY 1SPD			
		AVENUE CLASSIC 3SPD			
		SIT N'GO CEREMONY 1SPD			
26"		BOULEVARD ROYAL 6SPD			
		MYLADY CEREMONY 1SPD			
		TRENTO			
		NOSTALGIC CLASSIC 3SPD			
		NOSTALGIC CEREMONY 1SPD			
		BELLISSIMA CLASSIC 3SPD			
		BELLISSIMA ROYAL 6SPD			
		BELLISSIMA CEREMONY 1SPD			
		MISSY ROYAL 6SPD			
		ATLANTIS CLASSIC 3SPD			
		ATLANTIS ROYAL 6SPD			
		DEROCCA ROYAL 6SPD			
		DEROCCA CEREMONY ONE 1SPD			
		ESTRADA 1SPD			
	28"		DREAM CLASSIC 3SPD		
			DREAM CEREMONY 1SPD		
		SILUET ROYAL 6SPD			
		CORSO ROYAL 6SPD			
		NOSTALGIC PRESTIGE 7SPD			
		NOSTALGIC DELUXE 3SPD			
		NOSTALGIC CLASSIC 3SPD			
		NOSTALGIC ROYAL 6SPD			
		NOSTALGIC CEREMONY 1SPD			
		MONTERREY CLASSIC 3SPD			
		MONTERREY ROYAL 6SPD			
	MALENA CLASSIC 3SPD				
	LUIGI CLASSIC 3SPD				
	SIGNORA ROYAL 6SPD				

SMILE EVERY DAY

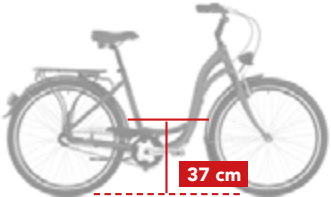
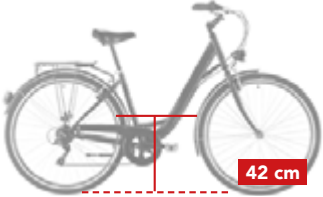

EASY STEP SYSTEM

LEVEL	VÝŠKA PREŠĽAPU (RÁM-ZEM) LOW STEP HEIGHT	VÝŠKA PREŠĽAPU (RÁM-ZEM) LOW STEP HEIGHT	MODEL
EASY STEP ①	0 – 30	 <p>EASY STEP ①</p> <p>13 cm</p>	SIT N' GO CEREMONY AVENUE CLASSIC
EASY STEP ②	31 – 41	 <p>EASY STEP ②</p> <p>37 cm</p>	DREAM CLASSIC / DREAM ROYAL / DREAM CEREMONY / SILUET ROYAL / CAMPING CLASSIC / CAMPING CEREMONY / DEROCCA ROYAL / DEROCCA CEREMONY ONE / BELLISSIMA ROYAL / BELLISSIMA CLASSIC / BELLISSIMA CEREMONY
EASY STEP ③	42 – 49	 <p>EASY STEP ③</p> <p>42 cm</p>	CORSO ROYAL / BOULEVARD ROYAL / MYLADY CEREMONY / MONIKA CEREMONY / LORETA CEREMONY / ATLANTIS CLASSIC / ATLANTIS ROYAL / NOSTALGIC PRESTIGE / NOSTALGIC DELUXE / NOSTALGIC CLASSIC / NOSTALGIC ROYAL / NOSTALGIC CEREMONY/ MISSY ROYAL / SIGNORA ROYAL
EASY STEP ④	50 – ...	 <p>EASY STEP ④</p> <p>50 cm</p>	TRENTO / ECOPOLIS / SIMPLYCITY / ESTRADA, MONTERREY ROYAL / MONTERREY CLASSIC / LUGI CLASSIC / MALENA CLASSIC

NOWADAYS THE COMFORT
AND CONVENIENCE
OF A LOW STEP
IS AVAILABLE TO EVERYONE



ŠPECIÁLNE
NÍZKOPREŠĽAPOVÉ RÁMY
TERAZ DOSTUPNÉ
PRE KAŽDÉHO





Comfort

DREAM DELUXE 7SPD

Available on request
with 7speed hub

Dostupné na požiadanie



503-1531

DREAM CLASSIC VC DR 3SPD



EASY²
STEP

RÁM/FRAME: Kenzel Aluminium

VIDLICA/FORK: Kenzel Hi-ten

VEĽKOSŤ RÁMU/FRAME SIZE: 46 cm

VEĽKOSŤ KOLIES/WHEEL SIZE: 26"/28"

PREDNÝ NÁBOJ/FRONT HUB: Aluminium

ZADNÝ NÁBOJ/FREEHUB: Shimano Nexus 3spd

BRZDY/BRAKES: TEKTRO V-brake / coaster brake

RÁFIKY/RIMS: RMK SOA COLOR GBS

HMOTNOSŤ/WEIGHT: 15 kg

510-1530



502-1531



511-1531



533-1531





533-1531



EASY²
STEP

DREAM ROYAL VV CR 6SPD

24" 26"

RÁM/FRAME: Kenzel Hi-ten

VIDICA/FORK: Kenzel Hi-ten

VEĽKOSŤ RÁMU/FRAME SIZE: 46 cm

VEĽKOSŤ KOLIES/WHEEL SIZE: 24"/26"

PREDNÝ NÁBOJ/FRONT HUB: Aluminium

ZADNÝ NÁBOJ/FREEHUB: Aluminium

RADENIE/SHIFTERS: Shimano Tourney SL-RS35 6spd

PREHADZOVAČ/REAR DERAILLEUR: Shimano Tourney RD-TZ500

REŤAZ/CHAIN: KMC Z7

KLUKY/CRANK SET: Detai Steel 46T

KAZETA/FREEWHEEL: Shimano MF-TZ500 6spd

BRZDY/BRAKES: Saccon V-Brake

RÁFIKY/RIMS: RMK SOA COLOR GBS

HMOTNOSŤ/WEIGHT: 16,7 kg



511-1531



502-1531



503-1531



510-1530





502-1531



503-1531



706-1530



533-1531



511-1531



510-1530



DREAM CEREMONY VV CR 1SPD

24" 26" 28"

EASY²
STEP

RÁM/FRAME: Kenzel Hi-ten

VIDLICA/FORK: Kenzel Hi-ten

VEĽKOSŤ RÁMU/FRAME SIZE: 46 cm

VEĽKOSŤ KOLIES/WHEEL SIZE: 24"/26"/28"

PREDNÝ NÁBOJ/FRONT HUB: Hi-ten

ZADNÝ NÁBOJ/FREEHUB: Hi-ten torpedo

BRZDY/BRAKES: Saccon V-brake / coaster brake

RÁFIKY/RIMS: RMK SOA Natural GBS

HĽADNOSŤ: 15,9 kg



LOW STEP THROUGH AND
A UNIQUELY DESIGNED FRAME

SUPER EASY TO GET ON AND OFF

STOP – SAFE CYCLING

COMFORTABLE

STABLE



503-1535



AVENUE CLASSIC VC DR 3SPD

26"

Easy¹
STEP

RÁM/FRAME: Kenzel Aluminium

VIDLICA/FORK: Kenzel Hi-ten

VEĽKOSŤ RÁMU/FRAME SIZE: 46 cm

VEĽKOSŤ KOLIES/WHEEL SIZE: 26"

PREDNÝ NÁBOJ/FRONT HUB: Aluminium

ZADNÝ NÁBOJ/FREEHUB: Shimano Nexus 3spd

BRZDY/BRAKES: TEKTRO V-brake / coaster brake

RÁFIKY/RIMS: RMK SOA COLOR GBS

HMOTNOSŤ/WEIGHT: 13,2 kg



511-1535



501-1535

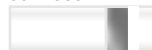

533-1535



510-1535





633-1538



SILUET ROYAL

6SPD

28"

RÁM/FRAME: Kenzel Aluminium

VIDLICA/FORK: SR Suntour NEX-HLO 700C

VEĽKOSŤ RÁMU/FRAME SIZE: 46 cm

VEĽKOSŤ KOLIES/WHEEL SIZE: 28"

PREDNÝ NÁBOJ/FRONT HUB: Aluminium

ZADNÝ NÁBOJ/FREEHUB: Aluminium

RADENIE/SHIFTERS: Shimano SL RS35 6spd

BRZDY/BRAKES: TEKTRO V-brake

RÁFIKY/RIMS: RMK ZION Color GBS

HMOTNOSŤ/WEIGHT: 16,1 kg



533-1538

Lifestyle Comfort

ENJOY EVERY MOMENT



502-1539



601-1538

NOVINKA

NEW
2020



511-1493

SIT N' GO CEREMONY VV CR 1SPD



EASY¹
STEP

RÁM/FRAME: Kenzel Hi-ten

VELKOST' RÁMU/FRAME SIZE: 40 cm

VELKOST' KOLIES/WHEEL SIZE: 20" / 26"

VIDLICA/FORK: Kenzel Hi-ten

PREDNÝ NÁBOJ/FRONT HUB: Hi-ten

ZADNÝ NÁBOJ/FREEHUB: Hi-ten torpedo

BRZDY/BRAKES: Saccon V-brake / coaster brake

RÁFIKY/RIMS: RMK SOA Natural GBS

HMOTNOST': 16,9 kg



704-1492



533-1491



510-1492



519-1492



503-1493

Oblíbené
u lidí so zníženou
pohybovou
schopnosťou alebo
s ťažkosťami
rovnováhy



EASY ①
STEP



For people who are having difficulty getting on and off a bike or people with slight balancing problems

13cm - 24"
16cm - 26"

Sit n'go is characterized by the "easy step" design, where the lower part of the main frame tube is laid as low as possible and horizontally to the ground. This makes it easier to get on and off the bike. Thanks to the frame design people with limited mobility and seniors will enjoy the bike.

Its design differs from conventional bicycles. The advantage of the bicycle is the lower center of gravity, which makes cycling more pleasant.

There are lot of accessories available to the bike such as baskets and mirrors, on order possible adjustment to e-bike.

EXTREMELY LOW STEP THROUGH BIKE
EXTRÉMNE NÍZKO PREŠLAPOVÝ BICYKEL

SUPER EASY TO GET ON AND OFF AND STOP
SUPER LAHKO SA NASADÁ A ZOSADÁ Z BICYKLA,
JEDNODUCHÉ ZASTAVENIE

SAFE CYCLING - ALWAYS WITH TWO FEET ON THE GROUND WITHOUT GETTING OFF
BEZPEČNÁ JAZDA NA BICYKLI - VŽDY OBE NOHY NA ZEMI BEZ NUTNOSTI ZOSADNÚŤ

ERGONOMICALLY DESIGNED SEATING - LESS BURDEN TO THE SHOULDERS, NECK AND BACK
ERGONOMICKY NAVRHNUTÉ SEDENIE - MENŠIE ZAŤAŽENIE NA PLECIA, KRK A CHRÁT

BICYCLE SUITABLE FOR ELDERLY AND OTHERS WITH RESTRICTED AGILITY
BICYKEL VHODNÝ PRE SENIOROV A PRE ĽUDÍ S OBMEDZENOU POHYBOVOU SCHOPNOSŤOU

COMFORTABLE
POHODLNÉ

STABLE
STABILNÉ

Sit n'go sa vyznačuje dizajnom "easy step", kde dolná časť hlavnej rámovej rúry je položená čo najnižšie a vodorovne k zemi. Umožňuje to jednoduchšie nasadnúť a zosadnúť z bicykla. Vďaka tejto konštrukcii rámu budú bicykel obľubovať ľudia s obmedzenou pohybovou schopnosťou a seniari.

Svojim dizajnom sa líši od bežných bicyklov. Výhodou bicykla je nižšie položené ťažisko, čo spríjemňuje jazdu na bicykli.

K bicyklu sú k dispozícii mnohé doplnky, ako sú košíky, zrkadlá, na objednávku možná úprava na elektrobicykel.



503-1279



CORSO ROYAL VV CR 6SPD



RÁM/FRAME: Kenzel Hi-ten
VELKOST' RÁMU/FRAME SIZE: 44 cm
VELKOST' KOLIES/WHEEL SIZE: 28"
VIDLICA/FORK: Kenzel Hi-ten
PREDNÝ NÁBOJ/FRONT HUB: Aluminium
ZADNÝ NÁBOJ/FREEHUB: Aluminium
RADENIE/SHIFTERS: Shimano Tourney SL-RS35 6spd

PREHADZOVAČ/REAR DERAILLEUR: Shimano Tourney RD-TZ500
REŤAZ/CHAIN: KMC Z7
KLUKY/CRANK SET: Detai Steel 46T
KAZETA/FREEWHEEL: Shimano MF-TZ500 6spd
BRZDY/BRAKES: Saccon V-brake
RÁFIKY/RIMS: RMK SOA Color GBS
HMOTNOSŤ: 17,1 kg



502-1279



513-1279



533-1280



609-1289



501-1289



511-1279



760-1280



502-1295





511-1309



BOULEVARD ROYAL VV CR 6SPD



RÁM/FRAME: Kenzel Hi-ten	PREHADZOVAČ/REAR DERAILLEUR: Shimano Tourney RD-TZ500
VEĽKOSŤ RÁMU/FRAME SIZE: 44 cm	REŤAZ/CHAIN: KMC Z7
VEĽKOSŤ KOLIES/WHEEL SIZE: 26"	KĽUKY/CRANK SET: Detai Steel 46T
VIDLICA/FORK: Kenzel Hi-ten	KAZETA/FREEWHEEL: Shimano MF-TZ500 6spd
PREDNÝ NÁBOJ/FRONT HUB: Aluminium	BRZDY/BRAKES: Saccon V-brake
ZADNÝ NÁBOJ/FREEHUB: Aluminium	RÁFIKY/RIMS: RMK SOA Color GBS
RADENIE/SHIFTERS: Shimano Tourney SL-RS35 6spd	HMOTNOSŤ: 16,6 kg



501-1309



760-1315



513-1309



503-1309



502-1309



533-1308



502-1310

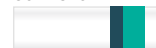



507/519-1328



MYLADY CEREMONY VV CR 1SPD



EASY ③
STEP

RÁM/FRAME: Kenzel Hi-ten

VELKOSTĚ RÁMU/FRAME SIZE: 47 cm

VELKOSTĚ KOLIES/WHEEL SIZE: 26"

VIDLICA/FORK: Kenzel Hi-ten

PREDNÝ NÁBOJ/FRONT HUB: Hi-ten

ZADNÝ NÁBOJ/FREEHUB: Hi-ten torpedo

BRZDY/BRAKES: Saccon V-brake / coaster brake

RÁFIKY/RIMS: RMK SOA Natural GBS

HMOTNOSTĚ: 15,4 kg



502/532-1329



533-1329



507/510-1328



COMFORT

Pleasant
CITY
RIDE



601-1317



TRENTO VV CR



EASY 4
STEP

RÁM/FRAME: Kenzel Hi-ten	PREŠMÝKAČ/FRONT DERAILLEUR: Shimano FDT-Z500
VEĽKOSŤ RÁMU/FRAME SIZE: MEN: 48 cm WOMEN: 43 cm	REŤAZ/CHAIN: KMC Z7
VEĽKOSŤ KOLIES/WHEEL SIZE: 26"	KLUKY/CRANK SET: Detai Steel 48/38/28T
VIDLICA/FORK: Kenzel Hi-ten	KAZETA/FREEWHEEL: Shimano MF-TZ500 6spd
PREDNÝ NÁBOJ /FRONT HUB: Aluminium	BRZDY/BRAKES: Saccon V-brake
ZADNÝ NÁBOJ/FREEHUB: Aluminium	RÁFIKY/RIMS: RMK SOA Natural GBS
RADENIE/SHIFTERS: Shimano Tourney SL-RS35 3x6spd	HMOTNOSŤ: 14,8 kg
PREHADZOVAČ/REAR DERAILLEUR: Shimano Tourney RD-TZ500	



533-1319



701-1319



514-1318



502-1318





502/532-1342



MONIKA CEREMONY VV CR 1SPD



RÁM/FRAME: Kenzel Hi-ten

VELKOST' RÁMU/FRAME SIZE: 43 cm

VELKOST' KOLIES/WHEEL SIZE: 24"

VIDLICA/FORK: Kenzel Hi-ten

PREDNÝ NÁBOJ/FRONT HUB: Hi-ten

ZADNÝ NÁBOJ/FREEHUB: Hi-ten torpedo

BRZDY/BRAKES: Saccon V-brake / coaster brake

RÁFIKY/RIMS: RMK SOA Natural GBS

HMOTNOSŤ: 14,7 kg



533-1342



503/889-1341



519-1342



Comfortable bikes for getting around your city.
Pohodlné bicykle na jazdu mestom.

THE FREEDOM TO DESIRE



502-1384



LORETA CEREMONY VV CR 1SPD

24"

Easy 3
STEP

RÁM/FRAME: Kenzel Hi-ten

VEĽKOSŤ RÁMU/FRAME SIZE: 45 cm

VEĽKOSŤ KOLIES/WHEEL SIZE: 24"

VIDLICA/FORK: Kenzel Hi-ten

PREDNÝ NÁBOJ/FRONT HUB: Hi-ten

ZADNÝ NÁBOJ/FREEHUB: Hi-ten torpedo

BRZDY/BRAKES: Saccon V-brake / coaster brake

RÁFIKY/RIMS: RMK SOA Natural GBS

HMOTNOSŤ: 14,5 kg

503-1384



511-1384



533-1384



510-1384





 **kenzel**[®]
bikemakers since 1991

Retro

*When
I get old
I will
Not be old
I will
be
Vintage*

NOSTALGIC

One and the only one. The Slovak original.

RetroGO 	VintiGO 	Prestige	DELuxe
28" 49 cm	28" 49 cm	28" 49 cm	28" 49 cm
165 cm - 185 cm	 165 cm - 185 cm	 165 cm - 185 cm	 165 cm - 185 cm
Nexus 7 prevodov / 7 gears	Nexus 7 prevodov / 7 gears	Nexus 7 prevodov / 7 gears	Nexus 3 prevody / 3 gears
 V-brzda/V-brake	 V-brzda/V-brake	vaľčková/Roller	vaľčková/Roller
 V-brzda/V-brake	Protišlapná brzda/Coaster brake	Protišlapná brzda/Coaster brake	Protišlapná brzda/Coaster brake
Rukoväte z prémiovej koženky/ Artificial leather grips	Rukoväte z prémiovej koženky/ Artificial leather grips	Rukoväte z prémiovej koženky/ Artificial leather grips	Rukoväte z prémiovej koženky/ Artificial leather grips
Pohodlné široké sedlo Deluxe z prémiovej koženky/ Comfortable saddle Deluxe	Pohodlné široké sedlo Deluxe z prémiovej koženky/ Comfortable saddle Deluxe	Pohodlné široké sedlo Deluxe z prémiovej koženky/ Comfortable saddle Deluxe	Pohodlné široké sedlo Deluxe z prémiovej koženky/ Comfortable saddle Deluxe
Shimano drive technology. Technológia pohonu Shimano.	Let's roll with power in front. Jazdíte so silou vpredu.	Extremely reliable brakes with no maintenance. Extrémne spoľahlivé brzdy bez údržby.	Alloy components make the bikes lighter. Zliatinové komponenty robia bicykel ľahším.

História Nostalgic

2008	2011	2013	2014	2015	2016	2017	2018
Dizajnuje sa Nostalgic Exclusive a Nostalgic Elegance.	Vzniká nový model Nostalgic DELuxe - pripomína časy minulé, ale je vybavený najnovšími dostupnými komponentmi.	Farebná škála Nostalgic DELuxe je doplnená pistáciovou, ktorá sa ihneď stala bestsellerom.	Farebná škála Nostalgic DELuxe je doplnená úžasnou lososovou farbou.	Nostalgic DELuxe sa ošatil do legendárneho krytu retaze s retro nádychom.	Nostalgic DELuxe sa parádí s elegantnými svetlami s LED technológiou od holandského výrobcu.	Nostalgic kolekcia sa rozrastá o model Nostalgic Classic, ktorá je osadená na 28" ale aj 26" kolesách.	Kolekcia Nostalgic od KENZEL je už v ponuke v 9 variáciách, aj ako elektrobicykel.

KENZEL NOSTALGIC a osobnosti / KENZEL NOSTALGIC and...



Michaela Luptáková
módna návrhárka a
stylistka fashion designer
and stylist



Eva Kramerová
stand up komička
a herečka, stand up
comedian and actress



Kristína Tormová
spisovateľka, herečka,
moderátorka, mama,
writer, actress, mom



Diana Mráziková
fotografka a žurnalistka,
bloggerka Havana Diaries
by Diana Mrazi
Multimedia journalist &
photographer, blogger
Havana Diaries by Diana
Mrazi

Fast & Elegant, Prestige & Deluxe, Royal & Classic, Ceremony. Just like every woman is a made up of myriad different shades, the Nostalgic reveals nine ways of interpreting the same bike. A detail can change everything. Discover KENZEL Nostalgic.

Rýchly a elegantný, Prestige a DELuxe, Royal a Classic, Ceremony. Rovnako ako každá žena, Nostalgic odhaľuje množstvo spôsobov interpretácie toho istého. Detail môže zmeniť všetko. Objavte Kenzel Nostalgic

Vyrobené na Slovensku. Handcrafted in Slovakia

Royal		Classic		Ceremony	
28"		28"		28"	
43 cm		43 cm		43 cm	
165 cm - 180 cm		165 cm - 180 cm	150-175 cm	165 cm - 180 cm	150-175 cm
6 prevodov / 6 gears		Nexus 3 prevody/3 gears	Nexus 3 prevody/3 gears	torpedo/single speed	torpedo/single speed
V-brzda/V-brake		V-brzda/V-brake		V-brzda/V-brake	
V-brzda/V-brake		Protišlapná brzda/Coaster brake		Protišlapná brzda/Coaster brake	
Rukoväte PVC/PVC grips		Rukoväte PVC/PVC grips		Rukoväte PVC/PVC grips	
Pohodlné mestské sedlo z koženky/ Comfortable saddle made of artificial leather		Pohodlné mestské sedlo z koženky/ Comfortable saddle made of artificial leather		Pohodlné mestské sedlo z koženky/ Comfortable saddle made of artificial leather	
A great value, simple and stylish city bike Cenovo dostupný, jednoduchý a štýlový.		The 26" wheel version is a perfect gift even for a young ladies. Model na 26" kolesách je ideálny darček pre mladé slečny.		Take a single when no hills will be challenged. Žiadne kopce, žiadne prevody.	

History of Nostalgic

2008	2011	2013	2014	2015	2016	2017	2018
Designing Nostalgic Exclusive a Nostalgic Elegance.	A new model is born as Nostalgic Deluxe.	A new pistacchi colour is added to the colour palette and becoming a bestseller in the new season.	A new beautiful salmon colour is added to the colour palette.	Nostalgic DELuxe is upgraded with a retro look chainguard.	Nostalgic DELuxe is upgraded with LED lights from Spanninga.	Nostalgic collection gets a new model Classic with variety of specs.	NEW ebikes are born in this collection. One of a kind. And now on already 9 variations of this beautiful collection.



Thaira
Kubánska speváčka,
Cuban Latin/Pop singer



Veronika Vargová
Miss Folklór 2016



Miriam Bystričanová
Miss Folklór 2017



Veronika Lattáková
Miss Folklór 2018



501-1396-1393



NOSTALGIC PRESTIGE RC DD 7SPD

28" 6061AL6061 LS Rigid fork COMETS EKO FEB

RÁM/FRAME: Kenzel Aluminium

VIDLICA/FORK: Kenzel Hi-ten

VEĽKOSŤ/SIZE: 49 cm

VEĽKOSŤ KOLIES/WHEEL SIZE: 28"

PREDNÝ NÁBOJ/FRONT HUB: Shimano HB-IM40

ZADNÝ NÁBOJ/FREEHUB: Shimano Nexus 7spd

BRZDY/BRAKES: Roller brake / coaster brake

RÁFIKY/RIMS: RMK SOA Color

HMOTNOSŤ: 17,3 kg

Ilustračné foto. Košík nie je súčasťou základnej výbavy bicykla./ Basket not included.

513-1391



503-1391



502-1391

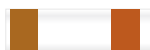

514-1393





NOSTALGIC

A master piece presenting the mature workmanship of bicycle creation. Its lasting quality and value shows in its slim and beautiful figure. This collection is an establishment of the supreme bicycle design.

Feel free to fall in love with this romantic retro range and be the main character on the streets with a vintage feeling.

 **kenzel**[®]
bikemakers since 1991



514-1393

NOSTALGIC DELUXE RC DD 3SPD



RÁM/FRAME: Kenzel Aluminium	ZADNÝ NÁBOJ/FREEHUB: Shimano Nexus 3spd
VIDLICA/FORK: Kenzel Hi-ten	BRZDY/BRAKES: Roller brake / coaster brake
VEĽKOSŤ/SIZE: 49 cm	RÁFIKY/RIMS: RMK SOA Color
VEĽKOSŤ KOLIES/WHEEL SIZE: 28"	HMOTNOSŤ: 16,6 kg
PREDNÝ NÁBOJ/FRONT HUB: Shimano HB-IM40	

*Váš život je čas s víziou.
Viete kto ste a čo chcete.
Od seba očakávate veľa,
preto je váš životný štandard vysoký.
Máte radi dokonalosť.
PRE SEBA VYBERÁTE LEN TO NAJLEPŠIE.*

To make this model line timeless we have thought it all: lightweight components, under paint stickers, neat design textures and suede detail.



RETRO ŠTÝL A ELEGANCIA RETRO STYLE AND ELEGANCE

SPOJENÉ V JEDNOM
ALL IN ONE

RETRO DIZAJN S MODERNÝMI KOMPONENTMI
A ŠIROKOU ŠKÁLOU FAREBNÝCH VARIANT.

RETRO DESIGN WITH MODERN COMPONENTS AND WIDE RANGE OF COLORS.

ROMANTICKÁ JAZDA
ROMANTIC RIDE



513-1391



503-1391



532-1393

SAMÁ ELEGANCIA
SIMPLY ELEGANCE



502-1391

*Ilustračné foto. Košík nie je súčasťou základnej
výbavy bicykla./ Basket not included.*



501-1393



502-1302

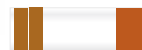

NOSTALGIC ROYAL VV CR 6SPD

28" 6061A T6061A LS RF Rigid fork EPO Clearwater Coating

RÁM/FRAME: Kenzel Aluminium	PREHADZOVAČ/REAR DERAILLEUR: Shimano Tourney RD-TZ500
VIDICA/FORK: Kenzel Hi-ten	REŘAZ/CHAIN: KMC Z7 6spd
VEĽKOSŤ/SIZE: 43 cm	PREVODNÍK S KLUKAMI/CRANK SET: Steel 42T
VEĽKOSŤ KOLIES/WHEEL SIZE: 28"	KAZETA/FREEWHEEL: Shimano MF-TZ500 14-28T 6spd
PREDNÝ NÁBOJ/FRONT HUB: Aluminium	BRZDY/BRAKES: Saccon V-brake
ZADNÝ NÁBOJ/FREEHUB: Aluminium	RÁFIKY/RIMS: RMK SOA Natural GBS
RADENIE/SHIFTERS: Shimano SL-RS35 6spd	HMOTNOSŤ: 15,5 kg



953-1302



503-1302



513-1302





604-1301

NOSTALGIC CLASSIC VC CR 3SPD

28" 26" 6061AL-T6 LS RF Rigid fork ECO Coating

RÁM/FRAME: Kenzel Aluminium	ZADNÝ NÁBOJ/FREEHUB: Shimano Nexus 3spd
VIDLICA/FORK: Kenzel Hi-ten	BRZDY/BRAKES: Saccon V-brake / coaster brake
VEĽKOSŤ RÁMU/FRAME SIZE: 43 cm	RÁFIKY/RIMS: RMK SOA Natural GBS
VEĽKOSŤ KOLIES/WHEEL SIZE: 26"/28"	HMOTNOSŤ: 15,9 kg
PREDNÝ NÁBOJ/FRONT HUB: Aluminium	

This bike will take your imagination straight to the streets of the city. Imagine yourself riding through the narrow passages, where the smell of roasted coffee gently caresses your senses, fountain breeze cools the hot skin and you hear the buzz of conversation around. It's all joined together in the spirit of NOSTALGIC CLASSIC.

Tento bicykel Vás preniesie rovno do ruchu mestských uličiek. Predstavte si spojenie vône praženej kávy, ktorá jemne hladí zmysly, vánok od fontány ochladzuje horúcu pokožku a v okolí počuť šum rozhovorov. Všetky tieto prvky sme spojili do jedného a vznikol jedinečný NOSTALGIC CLASSIC.



511-1301



513-1302



502-1304

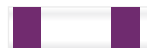

503-1302





The
passion
for
Tradition

NOSTALGIC CEREMONY

Srdca môjho šampión. Jednoduchý ale zároveň štýlový, uchváti každého jeho retro prevedením a určite viem, že keď prídem na ňom domov, prinesiem si okrem neobyčajného bicykla aj nostalgii, ktorá sa spája s dizajnom.

KATKA



501-1301



NOSTALGIC CEREMONY VC CR 1SPD

28" 26" 6061AL-T6 LS RF EPO Powder Coating

RÁM/FRAME: Kenzel Aluminium	ZADNÝ NÁBOJ/FREEHUB: Hi-ten torpedo
VIDICA/FORK: Kenzel Hi-ten	BRZDY/BRAKES: Saccon V-brake / coaster brake
VEĽKOSŤ/SIZE: 43 cm	RÁFIKY/RIMS: RMK SOA Natural GBS
VEĽKOSŤ KOLIES/WHEEL SIZE: 26"/28"	HMOTNOSŤ: 15 kg
PREDNÝ NÁBOJ/FRONT HUB: Hi-ten	

511-1301



502-1303

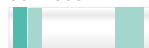

604-1301



503-1302





28" Royal

51 cm

165 cm - 180 cm

6 prevodov / 6 gears

701-1502

MONTERREY ROYAL VC CR 6SPD



RÁM/FRAME: Kenzel Aluminium	PREHADZOVAČ/REAR DERAILLEUR: Shimano Tourney RD-TZ500
VIDLICA/FORK: Kenzel Hi-ten	PREVODNÍK S KLUKAMI/CRANK SET: Hi-ten 42T
VEĽKOSŤ RÁMU/FRAME SIZE: 51 cm	KAZETA/FREEWHEEL: Shimano MF-TZ500 14-28T 6spd
VEĽKOSŤ KOLIES/WHEEL SIZE: 28"	BRZDY/BRAKES: Saccon V-brake
PREDNÝ NÁBOJ/FRONT HUB: Aluminium	RÁFIKY/RIMS: RMK SOA Natural GBS
ZADNÝ NÁBOJ/FREEHUB: Aluminium	HMOTNOSŤ: 15,6 kg
RADENIE/SHIFTERS: Shimano SL-RS35 6spd	



28" Classic

56 cm

51 cm

175 cm - 195 cm

165 cm - 180 cm

3 prevody / 3 gears

3 prevody / 3 gears



610-1502

601-1509

MONTERREY CLASSIC VC CR 3SPD



RÁM/FRAME: Kenzel Aluminium	ZADNÝ NÁBOJ/FREEHUB: Shimano Nexus 3spd
VIDLICA/FORK: Kenzel Hi-ten	BRZDY/BRAKES: Saccon V-brake / coaster brake
VEĽKOSŤ RÁMU/FRAME SIZE: 51/56 cm	RÁFIKY/RIMS: RMK SOA Natural GBS
VEĽKOSŤ KOLIES/WHEEL SIZE: 28"	HMOTNOSŤ: 15,5 kg
PREDNÝ NÁBOJ/FRONT HUB: Aluminium	



501-1381



LUIGI CLASSIC **3SPD**



RÁM/FRAME: Kenzel Lug Hi-ten
VIDICA/FORK: Kenzel Hi-ten
VELKOSŤ/SIZE: 60 cm
VELKOSŤ KOLIES/WHEEL SIZE: 28"
PREDNÝ NÁBOJ/FRONT HUB: Aluminium

ZADNÝ NÁBOJ/FREEHUB: Shimano Nexus 3spd
BRZDY/BRAKES: Caliper brake / coaster brake
RÁFIKY/RIMS: RMK SOA Natural GBS
HMOTNOSŤ: 17,1 kg

INSPIRED FROM THE TIME OF OUR NANNIES

Take this design piece wherever you want. Maybe a ride to your romantic café, picnic in the city park or a funky trip with your friend. Every bicycle of the Retro collection is distinctive in colours, top-of-the-range and comfortable just where you expect it.

INŠPIROVANÉ Z ČIAS NAŠICH BABIČIEK

Odveďte sa na tomto dizajnovom kúsku kamkoľvek chcete. Snáď do vašej romantickej kaviarničky, mestského parku na piknik alebo na funky výlet s kamoškou. Každý bicykel z kolekcie Retro je výrazný vo farbách, špičkový vo svojom vnútri a komfortný presne tam kde to očakávate.





502-1381



MALENA CLASSIC VC CR 3SPD



RÁM/FRAME: Kenzel Lug Hi-ten	ZADNÝ NÁBOJ/FREEHUB: Shimano Nexus 3spd
VIDLICA/FORK: Kenzel Hi-ten	BRZDY/BRAKES: Caliper brake / coaster brake
VEĽKOSŤ/SIZE: 55 cm	RÁFIKY/RIMS: RMK SOA Natural GBS
VEĽKOSŤ KOLIES/WHEEL SIZE: 28"	HMOTNOSŤ: 18,6 kg
PREDNÝ NÁBOJ/FRONT HUB: Aluminium	

Ilustračné foto. Košík nie je súčasťou základnej výbavy bicykla./ Basket not included.



514-1381



503-1381



536-1381



501-1381



BELLISSIMA

TIMELESS IN THE DESIGN BUT MODERN IN THE LOOK



901-1541



511-1541



953-1540



902-1540

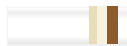

914-1540



503-1540



BELLISSIMA DELUXE 7SPD

Dostupné na požiadanie

Available on request
with 7speed hub



503-1540



BELLISSIMA CLASSIC VC CR 3SPD



RÁM/FRAME: Kenzel Aluminium

VIDLICA/FORK: Kenzel Hi-ten

VELKOSŤ RÁMU/FRAME SIZE: 46 cm

VELKOSŤ KOLIES/WHEEL SIZE: 26"

PREDNÝ NÁBOJ/FRONT HUB: Aluminium

ZADNÝ NÁBOJ/FREEHUB: Shimano Nexus 3

KLUKY/CRANK SET: Prowheel 42T

BRZDY/BRAKES: Tektro V-brake/coaster brake

RÁFIKY/RIMS: RMK SOA Natural GBS

HMOTNOSŤ: 15 kg



914-1540

BELLISSIMA ROYAL VC CR 6SPD



RÁM/FRAME: Kenzel Hi-ten	PREHADZOVAČ/REAR DERAILLEUR: Shimano Tourney RD-TZ500
VIDLICA/FORK: Kenzel Hi-ten	REŤAZ/CHAIN: KMC Z7
VEĽKOSŤ/SIZE: 46 cm	PREVODNÍK S KLUKAMI/CRANK SET: Steel 42T
VEĽKOSŤ KOLIES/WHEEL SIZE: 26"	KAZETA/FREEWHEEL: Shimano MF-TZ500 14-28T 6spd
PREDNÝ NÁBOJ/FRONT HUB: Aluminium	BRZDY/BRAKES: Saccon V-brake
ZADNÝ NÁBOJ/FREEHUB: Aluminium	RÁFIKY/RIMS: RMK SOA Natural GBS
RADENIE/SHIFTERS: Shimano Tourney SL-RS35 6spd	HMOTNOSŤ: 16,90 kg



902-1540



914-1540



511-1541



503-1540



901-1541



953-1540

Traverse the city streets in style.

Design that finds harmony of form and function, the Bellissima is a smooth, comfortable and easy-riding experience. With an upright sitting positioning and low step-through frame, the BELLISSIMA draws on both modern and classic retro design.

Available in a retro-inspired pastel color palette.



902-1540

BELLISSIMA CEREMONY VC CR 1SPD



RÁM/FRAME: Kenzel Hi-ten

VIDLICA/FORK: Kenzel Hi-ten

VEĽKOSŤ RÁMU/FRAME SIZE: 46 cm

VEĽKOSŤ KOLIES/WHEEL SIZE: 26"

PREDNÝ NÁBOJ/FRONT HUB: Hi-ten

ZADNÝ NÁBOJ/FREEHUB: Hi-ten torpedo

BRZDY/BRAKES: Saccon V-brake / coaster brake

RÁFIKY/RIMS: RMK SOA Natural GBS

HMOTNOSŤ: 16 kg



503-1540



914-1540



511-1541

SWAN :RETRO

RATTAN LOOK BASKET



196 - KOŠÍK, UMELÝ RATAN, HNEDÝ
224075-127008

Free basket
with selected bicycles

Košík zdarma
k vybraným modelom





914-1285



MISSY ROYAL VC CR 6SPD



RÁM/FRAME: Kenzel Hi-ten	PREHADZOVAČ/REAR DERAILLEUR: Shimano Tourney RD-TZ500
VIDICA/FORK: Kenzel Hi-ten	REŤAZ/CHAIN: KMC Z7
VELKOSŤ RÁMU/FRAME SIZE: 44 cm	PREVODNÍK S KLUKAMI/CRANK SET: Detai Steel 46T
VELKOSŤ KOLIES/WHEEL SIZE: 26"	KAZETA/FREEWHEEL: Shimano MF-TZ500 6spd
PREDNÝ NÁBOJ/FRONT HUB: Aluminium	BRZDY/BRAKES: Saccon V-brake
ZADNÝ NÁBOJ/FREEHUB: Aluminium	RÁFIKY/RIMS: RMK SOA Natural GBS
RADENIE/SHIFTERS: Shimano Tourney SL-RS35 6spd	HMOTNOSŤ: 16 kg



936-1286



503-1285

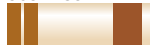

913-1285



502-1285

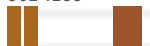



913-1287



SIGNORA ROYAL VC CR 6SPD



RÁM/FRAME: Kenzel Hi-ten	PREHADZOVAČ/REAR DERAILLEUR: Shimano Tourney RD-TZ500
VIDLICA/FORK: Kenzel Hi-ten	REŤAZ/CHAIN: KMC Z7
VEĽKOSŤ RÁMU/FRAME SIZE: 44 cm	PREVODNÍK S KĽUKAMI/CRANK SET: Detai Steel 46T
VEĽKOSŤ KOLIES/WHEEL SIZE: 28"	KAZETA/FREEWHEEL: Shimano MF-TZ500 6spd
PREDNÝ NÁBOJ/FRONT HUB: Aluminium	BRZDY/BRAKES: Saccon V-brake
ZADNÝ NÁBOJ/FREEHUB: Aluminium	RÁFIKY/RIMS: RMK SOA Natural GBS
RADENIE/SHIFTERS: Shimano Tourney SL-RS35 6spd	HMOTNOSŤ: 17,3 kg



914-1287



502-1287



953-1287



503-1287





502-518-552-1581
MARIN



ATLANTIS CLASSIC 3SPD

26"

RÁM/FRAME: Kenzel Hi-ten

VIDLICA/FORK: Kenzel Hi-ten

VELKOST' RÁMU/FRAME SIZE: 46 cm

VELKOST' KOLIES/WHEEL SIZE: 26"

PREDNÝ NÁBOJ/FRONT HUB: Aluminium

ZADNÝ NÁBOJ/FREEHUB: Shimano Nexus 3spd

BRZDY/BRAKE: Saccon V-brake / coaster brake

RÁFIKY/RIMS: RMK SOA Color GBS

HMOTNOST': 17,9 kg



503-514-1584
CREAMY





953-1590



ATLANTIS ROYAL 6SPD

26"

RÁM/FRAME: Kenzel Hi-ten	RADENIE/SHIFTERS: Shimano Tourney SL-RS35 6spd
VEĽKOSŤ RÁMU/FRAME SIZE: 46 cm	PREHADZOVAČ/REAR DERAILLEUR: Shimano Tourney RD-TZ500
VEĽKOSŤ KOLIES/WHEEL SIZE: 26"	REŤAZ/CHAIN: KMC Z7
VIDLICA/FORK: Kenzel Hi-ten	PREVODNÍK S KLUKAMI/CRANK SET: Detai Steel 46T
PREDNÝ NÁBOJ/FRONT HUB: Aluminium	KAZETA/FREEWHEEL: Shimano MF-TZ500 6spd
ZADNÝ NÁBOJ/FREEHUB: Aluminium	RÁFIKY/RIMS: RMK SOA Natural GBS
BRZDY/BRAKES: Saccon V-brake	HMOTNOSŤ: 17,7 kg

Ilustračné foto košíka. Košík sa môže meniť v závislosti od dostupnosti./ Basket may vary based on availability.



914-1590



**KRÁSNE TVAROVANÝ RÁM,
MODERNÉ FAREBNÉ KOMBINÁCIE**

**BEAUTIFULLY SHAPED FRAME,
MODERN COLOR COMBINATIONS**



609-1522



601-1523

DEROCCA ROYAL 6SPD

26"

RÁM/FRAME: Kenzel Hi-ten

VEĽKOSŤ RÁMU/FRAME SIZE: 46 cm

VEĽKOSŤ KOLIES/WHEEL SIZE: 26"

VIDLICA/FORK: Kenzel Hi-ten

PREDNÝ NÁBOJ/FRONT HUB: Aluminium

ZADNÝ NÁBOJ/FREEHUB: Aluminium

BRZDY/BRAKES: Saccon V-brake

RADENIE/SHIFTERS: Shimano Tourney SL-RS35 6spd

PREHADZOVAČ/REAR DERAILLEUR: Shimano Tourney RD-TZ500

REŤAZ/CHAIN: KMC Z7

PREVODNÍK S KLUKAMI/CRANK SET: Detai Steel 46T

KAZETA/FREEWHEEL: Shimano MF-TZ500 6spd

RÁFIKY/RIMS: RMK SOA Natural GBS

HMOTNOSŤ: 17,7 kg



601-1523



609-1522

DEROCCA CEREMONY 1SPD

26"

RÁM/FRAME: Kenzel Hi-ten

VIDLICA/FORK: Kenzel Hi-ten

VEĽKOSŤ/SIZE: 46 cm

VEĽKOSŤ KOLIES/WHEEL SIZE: 26"

PREDNÝ NÁBOJ/FRONT HUB: Hi-ten

ZADNÝ NÁBOJ/FREEHUB: Hi-ten torpedo

BRZDY/BRAKE: Saccon V-brake / coaster brake

RÁFIKY/RIMS: RMK SOA Color GBS

HMOTNOSŤ: 16,70 kg

 **kenzel**[®]
bikemakers since 1991

*Najštýlovejši
doplnok do mesta*

Cruis and rock



Urban





701-1131

ECOPOLIS 6SPD



RÁM/FRAME: Kenzel folding Aluminium	PREHADZOVAČ/REAR DERAILLEUR: Shimano TOURNEY RD-FT35
VIDLICA/FORK: Kenzel Aluminium	REŤAZ/CHAIN: KMC Z7
VEĽKOSŤ RÁMU/FRAME SIZE: 29 cm	KAZETA/FREEWHEEL: Shimano MF-TZ500
VEĽKOSŤ KOLIES/WHEEL SIZE: 20"	BRZDY/BRAKES: TEKTRÖ V-brake
PREDNÝ NÁBOJ/FRONT HUB: FORMULA OV-31	RÁFIKY/RIMS: RMK SOA Color GBS
ZADNÝ NÁBOJ/FREEHUB: FORMULA OV-31	HMOTNOSŤ: 13,90 kg
RADENIE/SHIFTERS: Shimano SL-RS35 6spd	



SKLADACIE PEDÁLE IZY-FOLP™

Praktické skladacie pedále, ktoré Vám ušetria ďalšie potrebné miesto v byte či v aute. Telo pedálu tvorí pevná konštrukcia z odolného hliníku, ktorý výborne znáša každodenné skladanie.

Practical folding pedals to save you more space in your apartment or car. The body of the pedal forms a solid construction made of durable aluminum that perfectly carries the daily folding.



LAHKO NASTAVITEĽNÝ PREDSTAVEC

Sklopný predstavec je výškovo nastaviteľný. Umožňuje si ho jednoducho prispôsobiť podľa výšky a potreby jazdca a tak znásobiť jazdný komfort.

Folding stem is height adjustable. You can easily adapt to the rider's height and ride, thus maximizing driving comfort.



POHODLNÉ SEDLO COMFI SIT™

Jeho príjemný tvar je pripravený zvládnuť všetky cestné nerovnosti a tlmiť nárazy.

COMFI SIT™ saddle. Its pleasant shape is ready to handle all road inequalities and damping impacts.



INOVATÍVNY SKLADACÍ MECHANIZMUS RnF™

Technológia Ride n' Fold - RnF™ je skladací mechanizmus, pomocou ktorého bicykel ľahko zložíte za pár sekúnd vrátane pedálov. Pri troche cviku to zvládnete za cca 10-15 sekúnd. So skladacím mechanizmom RnF™ nebudete mať problém uskladiť bicykel aj v tom najmenšom byte.

Ride n'Fold - RnF™ is a folding mechanism that makes your bike easy to fold in seconds. With a little exercise you can do it in about 10-15 seconds.



HYFORK™

Hydroformigom tvarovaná hliníková vidlica je oproti ocelovým ľahšia a tak si ušetríte váhu môžete smelo vynahradiť väčším nákupom alebo batožinou.

Hydroformigom shaped aluminum fork is lighter than Steel, so you can easily save your weight by making bigger shopping or load more luggage.



POVRCHOVÁ ÚPRAVA GREEN-SMART SURFACE™

Technológia GREEN-SMART SURFACE™ je ekologická povrchová úprava s aplikáciou práškových farieb, ktoré sú šetrné k životnému prostrediu, šetria energiu a zdroje, neobsahujú rozpúšťadlá, iné prchavé organické látky a ponúkajú trvalú a odolnú ochranu na našich produktoch.

GREEN-SMART SURFACE™ technology is environmentally friendly powder coating with solvent-free, other volatile organic compounds and offer lasting and durable protection on our products.



SKLADANIE TECHNOLOGIUI MAGNETIC™

V zloženom stave je rám pevne fixovaný pomocou magnetického držaču. A pretože sa dá zložiť, môže sa s vami vydať naozaj kamkoľvek.

Postup skladania bicykla

Spustiť sedlo

Sklopiť predstavec smerom dole

Zložiť bicykel v hlavnom rámovom kĺbe

Spojiť prednú a zadnú časť bicykla magnetickými držiakmi

Sklopiť pedále



PRIRODENÁ FORMA DOPRAVY

Jazda na bicykli je úplne prirodzenou formou dopravy, je obzvlášť zdraviu prospešná, rýchla, elegantná a minimálne nákladná.

Cycling is an entirely natural form of transport, especially healthy, beneficial, fast, elegant and minimally costly.



UNIVERZÁLNOŠŤ V SPOJENÍ S TECHNOLOGIUI MAHYT™

Ecopolis má univerzálny ľahký hliníkový rám tvarovaný technológiou MAHYT™. Je pevný, odolný voči korózii a odoláva únave. Ecopolis je vhodný pre mužov aj ženy a je určený na pohodlné jazdenie v meste a jeho okolí, na každodenné dochádzanie do práce, ľahko ho vezmete so sebou do vlaku, či schováte do kufra auta, aby ste ho mohli využiť na chate alebo na dovolenke.

Ecopolis has a universal lightweight aluminum frame molded by MAHYT™ technology. It is robust, corrosion resistant and resistant to fatigue. The Ecopolis is suitable for both men and women and is designed for a comfortable ride in the city for everyday commuting, easily take it with you to the train or hide in the suitcase of your car.



FULL PACKET VŠETKO V JEDNOM

Súčasťou tohto bicykla sú všetky doplnky potrebné na jazdu po pozemných komunikáciách. Ecopolis je plne vybavený LED osvetlením, ktoré Vám zabezpečí nielen dostatočnú viditeľnosť a bezpečnosť na cestách, ale zároveň dotvorí celkový príjemný vzhľad bicykla. Samozrejmosťou sú blatníky, zadný nosič, ktorého nosnosť je 25 kg a v neposlednom rade kvalitné plášte s reflexným pásikom.

This bike has all the accessories needed to ride on the road. Ecopolis is fully equipped with LED lighting, which will provide you visibility and road safety. Of course, there are mudguards, a rear carrier with a load of 25 kg and last but not least a high-quality tyres with reflective stripe.



601-1129

SIMPLYCITY VC CR 3SPD



RÁM/FRAME: Kenzel folding Aluminium	ZADNÝ NÁBOJ/FREEHUB: Shimano Nexus 3spd
VIDLICA/FORK: Kenzel Hi-ten	BRZDY/BRAKES: Saccon V-brake / coaster brake
VEĽKOSŤ RÁMU/FRAME SIZE: 29 cm	RÁFIKY/RIMS: RMK SOA Natural GBS
VEĽKOSŤ KOLIES/WHEEL SIZE: 20"	HĽADNOSŤ: 13,8 kg
PREDNÝ NÁBOJ/FRONT HUB: Aluminium	

Moja životná filozofia je prostá. Oceňujem všetko, čo vyhovuje mojim zvykom a možnostiam. Vyberám si to, čo rešpektuje môj životný štýl. Simplycity sa stal súčasťou môjho spôsobu života, pretože sa prispôsobuje mne, a nie naopak.

My life philosophy is simple. I appreciate everything that suits my habits and possibilities. I choose what respects my lifestyle. Simplycity has become part of my way of life, it adapts to me.





533-1249



CAMPING CLASSIC VC CR 3SPD

20"

LS

RF

Eco Coating

RÁM/FRAME: Kenzel Hi-ten

VELKOSŤ RÁMU/FRAME SIZE: 40 cm

VELKOSŤ KOLIES/WHEEL SIZE: 20"

VIDLICA/FORK: Kenzel Hi-ten

PREDNÝ NÁBOJ/FRONT HUB: Aluminium

ZADNÝ NÁBOJ/FREEHUB: Shimano Nexus 3spd

BRZDY/BRAKES: Saccon V-brake / coaster brake

RÁFIKY/RIMS: RMK SOA Natural GBS

HMOTNOSŤ: 15,3 kg



503-1250



510-1249



511-1249



502-1250

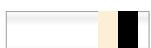

CAMPING CEREMONY VC CR 1SPD

20"

LS

RF

Eco Coating

RÁM/FRAME: Kenzel Hi-ten

VELKOSŤ RÁMU/FRAME SIZE: 40 cm

VELKOSŤ KOLIES/WHEEL SIZE: 20"

VIDLICA/FORK: Kenzel Hi-ten

PREDNÝ NÁBOJ/FRONT HUB: Hi-ten

ZADNÝ NÁBOJ/FREEHUB: Hi-ten torpedo

BRZDY/BRAKES: Saccon V-brake / coaster brake

RÁFIKY/RIMS: RMK SOA Natural GBS

HMOTNOSŤ: 14,6 kg



601-1272



*With the belief cycling will make
a better city life experience*



502-1271

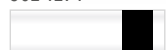

ESTRADA

RÁM/FRAME: Kenzel fixie Hi-ten

VEĽKOSŤ RÁMU/FRAME SIZE: MEN: 49/54 cm WOMEN: 48 cm

VIDLICA/FORK: Kenzel Hi-ten

PREDNÝ NÁBOJ/FRONT HUB: Joy Tech A165DSE

ZADNÝ NÁBOJ/FREEHUB: Joy Tech A166DSE Fix/Free

KLUKY/CRANK SET: Aluminium 46T

KAZETA/FREEWHEEL: 16T

BRZDA/ BRAKE: Caliper

RÁFIKY/RIMS: Fixie Color GBS

HMOTNOSŤ: 12 kg/11,7 kg

URBAN



UROBTE SI Z JAZDY V MESTSKEJ DŽUNGI

PÔŽITOK. ČISTÉ LÍNIE, ELEGANCIA

A SPOĽAHLIVOSŤ SÚ TOU IDEÁLNOU

KOMBINÁCIOU TOHTO BICYKLA. PRIDAJTE SA

MILOVNÍKOM SINGLE SPEED UŽ DNES.



COMPARISON/POROVNANIE LIFESTYLE

POROVNANIE BICYKLOV COMPARISON OF BIKES	Dream Classic	Dream Royal	Dream Ceremony	Avenue Classic	Siluet Royal	Sit n´ GO Ceremony	Corso Royal	Boulevard Royal	MyLady Ceremony	Trento	Monika Ceremony	Loreta Ceremony
VELKOSŤ KOLIES WHEEL SIZE												
20"						X						
24"		X	X								X	X
26"	X	X	X	X		X		X	X	X		
28"	X		X		X		X					
MATERIÁL RÁMU FRAME MATERIAL												
OCEĽ / HI-TEN	X	X	X			X	X	X	X	X	X	X
HLINÍK / ALUMINIUM	X		X	X	X							
VELKOSŤ RÁMU FRAME SIZE	46	46	46	46	46	40	44	44	47	43/48	43	45
NÍZKOPREŠĽAPOVÝ SYSTEM EASY STEP SYSTEM	②	②	②	①	②	①	③	③	③	④	③	③
VÝŠKA PREŠĽAPU (RÁM-ZEM) LOW STEP HEIGHT	37	38	38	27,5	41	13/16	42	44	44	50/74	43	44
VÝBAVA EQUIPPED												
PRESTIGE												
ROYAL		X			X		X	X				
DELUXE												
CLASSIC	X			X								
CEREMONY			X			X			X		X	X
POČET PREVODOV GEARS												
1 R / 1 SPD			X			X			X		X	X
3 R / 3 SPD	X			X								
6 R / 6 SPD		X			X		X	X				
7 R / 7 SPD	X			X								
18 R / 18 SPD										X		
DOPLNKY ACCESSORIES												
BLATNÍKY MUDGUARDS	X	X	X	X	X	X	X	X	X	X	X	X
BOČNÝ STOJAN / KICKSTAND	X	X	X	X	X	X	X	X	X	X	X	X
KOŠÍK / BASKET	X	X		X			X	X				
KRYT REŤAZE / CHAINGUARD	X	X	X	X	X	X	X	X	X	X	X	X
OSVETLENIE / LIGHTS	X	X	X	X	X	X	X	X	X	X	X	X
ZADNÝ NOSIČ / REAR CARRIER	X	X	X	X	X	X	X	X	X	X	X	X
ZVONČEK / BELL	X	X	X	X	X	X	X	X	X	X	X	X

COMPARISON/POROVNANIE LIFESTYLE

POROVNANIE BICYKLOV COMPARISON OF BIKES	Ecopolis	SimplyCity	Camping Classic	Camping Ceremony	Estrada	Atlantis Classic	Atlantis Royal	Derocca Royal	Derocca Ceremony One
VELKOSŤ KOLIES WHEEL SIZE									
20"	X	X	X	X					
24"									
26"					X	X	X	X	X
28"									
MATERIÁL RÁMU FRAME MATERIAL									
OCEĽ / HI-TEN			X	X	X	X	X	X	X
HLINÍK / ALUMINIUM	X	X							
VELKOSŤ RÁMU FRAME SIZE	29	29	40	40	48	46	46	46	46
NÍZKOPREŠĽAPOVÝ SYSTÉM EASY STEP SYSTEM	④	④	②	②	④	③	③	④	④
VÝŠKA PREŠĽAPU (RÁM-ZEM) LOW STEP HEIGHT	56	54	35	35	53	42	42	82	82
VÝBAVA EQUIPPED									
PRESTIGE									
ROYAL							X	X	
DELUXE									
CLASSIC			X			X			
CEREMONY				X					X
POČET PREVODOV GEARS									
1 R / 1 SPD				X	X				X
3 R / 3 SPD		X	X			X			
6 R / 6 SPD	X						X	X	
7 R / 7 SPD									
18 R / 18 SPD									
DOPLNKY ACCESSORIES									
BLATNÍKY MUDGUARDS	X	X	X	X	X	X	X	X	X
BOČNÝ STOJAN / KICKSTAND	X	X	X	X	X	X	X	X	X
KOŠÍK / BASKET							X		
KRYT REŤAZE / CHAINGUARD	X	X	X	X	X	X	X	X	X
OSVETLENIE / LIGHTS	X	X	X	X	X	X	X	X	X
ZADNÝ NOSIČ / REAR CARRIER	X	X	X	X	X	X	X	X	X
ZVONČEK / BELL	X	X	X	X	X	X	X	X	X

COMPARISON/POROVNANIE LIFESTYLE

POROVNANIE BICYKLOV COMPARISON OF BIKES	Nostalgic Prestige	Nostalgic Deluxe	Nostalgic Royal	Nostalgic Classic	Nostalgic Ceremony	Monterrey Royal	Monterrey Classic	Luigi Classic	Malena Classic	Bellissima Classic	Bellissima Royal	Bellissima Ceremony	Missy Royal	Signora Royal
VELKOSŤ KOLIES WHEEL SIZE														
20"														
24"														
26"				X	X					X	X	X	X	
28"	X	X	X	X	X	X	X	X	X					X
MATERIÁL RÁMU FRAME MATERIAL														
OCEĽ / HI-TEN								X	X		X	X	X	X
HLINÍK / ALUMINIUM	X	X	X	X	X	X	X			X				
VELKOSŤ RÁMU FRAME SIZE	49	49	43	43	43	51	51/56	60	55	46	46	46	44	44
NÍZKOPREŠĽAPOVÝ SYSTÉM EASY STEP SYSTEM	③	③	③	③	③	④	④	④	③	②	②	②	③	③
VÝŠKA PREŠĽAPU (RÁM-ZEM) LOW STEP HEIGHT	47	47	49	49	49	79	79	85	49	37	38	38	44	42
VÝBAVA EQUIPPED														
PRESTIGE	X													
ROYAL			X			X					X		X	X
DELUXE		X												
CLASSIC				X			X	X	X	X				
CEREMONY					X							X		
POČET PREVODOV GEARS														
1 R / 1 SPD					X							X		
3 R / 3 SPD		X		X			X	X	X	X				
6 R / 6 SPD			X			X					X		X	X
7 R / 7 SPD	X									X				
18 R / 18 SPD														
DOPLNKY ACCESSORIES														
BLATNÍKY MUDGUARDS	X	X	X	X	X	X	X	X	X	X	X	X	X	X
BOČNÝ STOJAN / KICKSTAND	X	X	X	X	X	X	X	X	X	X	X	X	X	X
KOŠÍK / BASKET			X	X	X					X	X	X	X	X
KRYT RĚTÁZE / CHAINGUARD	X	X	X	X	X	X	X	X	X	X	X	X	X	X
OSVETLENIE / LIGHTS	X	X	X	X	X	X	X	X	X	X	X	X	X	X
ZADNÝ NOSIČ / REAR CARRIER	X	X	X	X	X	X	X	X	X	X	X	X	X	X
ZVONČEK / BELL	X	X	X	X	X	X	X	X	X	X	X	X	X	X

POROVNANIE VÝBAVY LIFESTYLE RETRO

	VÝBAVA EQUIPPED	PREVODY/ SPEED		BRZDY BRAKES	LÚBIŠ TOČIŤ PEDÁLMI DOZADU? DO YOU LIKE TO PEDAL BACKWARDS?		SEDLO SADDLE		RUKOVÄTE GRIPS
+++++	PRESTIGE	7R / 7SPD	RR DD	ROLLER/ ROLLER	ÁNO/YES	D	Exkluzívne široké sedlo Deluxe z prémiovej koženky Exclusive saddle Deluxe made of premium material	D	Prémiové rukoväte z koženky Premium artificial leather grips
+++++		7R / 7SPD	RR DD	ROLLER/ COASTER	NIE/NO	D	Exkluzívne široké sedlo Deluxe z prémiovej koženky Exclusive saddle Deluxe made of premium material	D	Prémiové rukoväte z koženky Premium artificial leather grips
+++++		7R / 7SPD	VC DR	V/COASTER	NIE/NO	D	Exkluzívne široké sedlo Deluxe z prémiovej koženky Exclusive saddle Deluxe made of premium material	R	Pohodlné gumené rukoväte Comfortable rubber grips
+++++	ROYAL	6R / 6SPD	VC DR	V/V	ÁNO/YES	D	Pohodlné mestské sedlo Classic Feliz z koženky Comfortable city saddle Classic Feliz made from artificial leather	R	Pohodlné gumené rukoväte Comfortable rubber grips
+++++	DELUXE	3R / 3SPD	RC DD	ROLLER/ COASTER	NIE/NO	D	Exkluzívne široké sedlo Deluxe z prémiovej koženky Exclusive saddle Deluxe made of premium material	D	Prémiové rukoväte z koženky Premium artificial leather grips
+++++	CLASSIC	3R / 3SPD	VC DR	V/COASTER	NIE/NO	D	Exkluzívne široké sedlo Deluxe z prémiovej koženky Exclusive saddle Deluxe made of premium material	R	Pohodlné gumené rukoväte Comfortable rubber grips
+++++		3R / 3SPD	VC CR	V/COASTER	NIE/NO	D	Pohodlné mestské sedlo Classic Feliz z koženky Comfortable city saddle Classic Feliz made from artificial leather	R	Pohodlné gumené rukoväte Comfortable rubber grips
+++++	CEREMONY	1R / 1SPD	VC CR	V/COASTER	NIE/NO	D	Pohodlné mestské sedlo Classic Feliz z koženky Comfortable city saddle Classic Feliz made from artificial leather	R	Pohodlné gumené rukoväte Comfortable rubber grips



Vedeli ste, že:

- sedlá a koženkové rukoväte sa ručne vyrábajú v Ramon Di Loria v Taliansku
- dvojstenné hliníkové ráfiky pochádzajú z našej domácej výroby z Hurbanova
- bicykel a jeho komponenty sú ručne lakované v Hurbanove ekologickými práškovými farbami, ktoré starostlivo vyberáme
- svoj bicyklový rídikel si môžete dotvoriť aj podľa vlastného gusta vďaka našej širokej ponuke doplnkov

RUKY HORE, KTO SA TEŠÍ VON!



MINI 2-5 ROKOV / YEARS

KIDS 5+ ROKOV / YEARS

TEENS 10+ ROKOV / YEARS



WE ARE THE SUPER TEAM!

WITH OUR GREAT RANGE OF KIDS BIKES, YOUR LITTLE ONES WILL BE ALL SET TO EXPERIENCE THE JOYS OF EXPLORING THE WORLD ON TWO WHEELS. SPECIFICALLY DESIGNED TO SUIT SMALLER BODIES, OUR KIDS BIKES OFFER THE PERFECT RIDE TO GET OUT AND BE FREE, BECAUSE WE BELIEVE MUCH MORE CAN HAPPEN IN LIFE ON TWO WHEELS.

VĎAKA NAŠEJ ŠIROKEJ PONUKE DETSKÝCH BICYKLOV BUDÚ VAŠE DETI PRIPRAVENÉ ZAŽIŤ RADOSTI Z OBJAVOVANIA SVETA NA DVOCH KOLESÁCH. NAŠE DETSKÉ BICYKLE, SÚ ŠPECIÁLNE NAVRHNUTÉ TAK, ABY VYHOVOVALI NAJMENŠÍM A PONÚKLI DOKONALÚ JAZDU.



	RETRO	CITY	ADVENTURE	SPORT
	RETRO	MESTSKÉ	REKREAČNÉ	ŠPORTOVÉ
12"			RIDE PHANTOM	
			LOOPI / FYOO	
			ZIGGY RF12	
16"			ZIGGY RF16	
			LIME/LIMA RF16	
		LUNA CEREMONY 16		
		LIMA CEREMONY 16		
20"			ZIGGY RF20	
			KALEO/KALEA RF20	
			ROXIS SF20	
			WIND SF200	
			NINA CEREMONY 20	
	BELLA ROYAL 20			
24"			VULCANO 300 SF24	
			VULCANO 100 SF24	
			RARITY SF24	
			ROXIS SF24	
			WIND SF300	
			AXEL SF24	
			YUM RF24	
			COMPACT RF24	
		BELLA ROYAL 24		
		ATLANTIS CEREMONY 24		
26"			SHADE SF26 JUNIOR	
700C			CALIBRE 400 JUNIOR	



Wear reflective elements so drivers can easily spot you.

Používajte reflexné prvky, aby Vás vodiči mohli ľahko spoznať.

THE BEST FRIENDS CLUB

KLUB NAJLEPŠÍCH PRIATEĽOV



KENZLÍK KIDS CYCLING CLUB
DETSKÝ CYKLISTICKÝ KLUB

#SKENZLIKOMNABICYKLI
Je zábavno edukačná knižka pre malých cyklistov.





THE MAGIC
MOMENT
THAT WILL
LAST

LOOPI [LUPI]



RÁM/FRAME: Kenzel aluminium

VELKOSŤ RÁMU/FRAME SIZE: Adjustable saddle from 330mm to 450mm

Nastavitelné sedlo od 330 mm do 450 mm

VELKOSŤ KOLIES/WHEEL SIZE: 12"

VIDLICA/FORK: Aluminium

PREDNÝ NÁBOJ/FRONT HUB: Hi-ten

ZADNÝ NÁBOJ/FREEHUB: Hi-ten

HMOTNOSŤ/WEIGHT: 3,50 kg



ODRÁŽADLO JE AZDA NAJVHODNEJŠOU „HRAČKOU“ PRE DIEŤA. JAZDENIE NA ODRÁŽADLE ROZVÍJA ROVNOVÁHU A OBRATNOSŤ DIEŤAŤA, JEHO SCHOPNOSŤ CHODIŤ A BEHAŤ A NESKÔR AJ JAZDIŤ NA BICYKLI.

RIDING ON A BALANCE BIKE DEVELOPS CHILD'S BALANCE AND DEXTERITY, ITS ABILITY TO WALK AND RUN, AND LATER TO RIDE A BICYCLE.

**LIGHT, DURABLE
AND LOOKS FANTASTIC!**

ĽAHKÝ, ODOLNÝ A NAVYŠE FANTASTICKY VYZERÁ!

FYOO [FIJU]

- LIGHTWEIGHT ALUMINIUM FRAME AND FORK INTEGRATED
- REMOVABLE FOOTRESTS ON SEAT TUBE
- HEIGHT ADJUSTABLE SADDLE
- HANDLEBARS 360MM
- 12" WHEELS
- HANDLEBAR LOCK
- WEIGHT 3,12KG



- ĽAHKÝ HLINÍKOVÝ RÁM A VIDLICA
- ODNÍMATEĽNÉ STUPAČKY NA SEDLOVEJ TRUBKE
- VÝŠKOVY NASTAVITEĽNÉ SEDLO
- RIADIDLÁ 360MM
- 12PALCOVÉ PLÁŠŤOVÉ KOLESÁ
- POISTKA PROTI PRETOČENIU RIADITOK
- HMOTNOSŤ 3,12KG



RÁM/FRAME: Kenzel aluminium
VEĽKOSŤ RÁMU/FRAME SIZE: Adjustable saddle from 330mm to 450mm
Nastaviteľné sedlo od 330 mm do 450 mm
VEĽKOSŤ KOLIES/WHEEL SIZE: 12"

VIDLICA/FORK: Aluminium
PREDNÝ NÁBOJ/FRONT HUB: Hi-ten
ZADNÝ NÁBOJ/FREEHUB: Hi-ten
HMOTNOSŤ/WEIGHT: 3,12 kg

RIDE PHANTOM
THE BRIGHTEST IDEA IN YOUR MIND

PULSAR



BLUE



GREEN



RED



WHITE

LIGHTING BALANCE BIKE / SVIETIACE ODRÁŽADLO

A GREAT ENTERTAINMENT FOR YOUR CHILDREN FOR A LONG TIME THANKS TO ADJUSTABLE COMPONENTS

SKVELÁ ZÁBAVA PRE VAŠE DETI NA DLHÉ OBDOBIE VĎAKA NASTAVITEĽNÝM KOMPONENTOM

ALWAYS BE VISIBLE

- INTERNALLY ILLUMINATED POLYCARBONATE FRAME
- 12" PNEUMATIC EASY ROLL RUBBER TIRES
- SADDLE W/HANDLE
- FRONT AND REAR LED LIGHT INSERTS - PICK YOUR COLOR FROM 4 OPTIONS
- EASY-TO-ADJUST SEAT AND HANDLEBAR HEIGHT FOR THE GROWING CHILD
- REPLACEABLE LED LIGHTS INCLUDED WITH WHICH YOUR CHILD WILL **BE ALWAYS VISIBLE**

- VNÚTORNE OSVETLENÝ POLYKARBONÁTOVÝ RÁM
- 12" PLÁŠTE EASY ROLL
- SEDLO S RÚČKOU
- PREDNÉ A ZADNÉ LED SVETELNÉ VLOŽKY - VYBER SI ZO 4 FARIEB
- ĽAHKO NASTAVITEĽNÁ VÝŠKA SEDADLA A RIADITOK PRE RASTÚCE DIEŤA
- VYMENITEĽNÉ LED SVIETIDLÁ, S KTORÝMI BUDE VAŠE DIEŤA **VŽDY VIDITEĽNÉ**

RÁM/FRAME: Polycarbonate

VEĽKOSŤ RÁMU/FRAME SIZE: 18 cm

VEĽKOSŤ KOLIES/WHEEL SIZE: 12"

VIDLIČKA/FORK: Hi-ten

PREDNÝ NÁBOJ/FRONT HUB: Hi-ten

ZADNÝ NÁBOJ/FREEHUB: Hi-ten

HMOTNOSŤ/WEIGHT: 4,5 kg

- OD/FROM 90 CM
- BEZPEČNÉ/SAFE
- ĽAHKO OVLÁDATEĽNÉ/EASY HANDLING
- ŠPECIÁLNA GEOMETRIA RÁMU/
SPECIAL FRAME GEOMETRY
- OCEĽOVÁ VIDLICA/STEEL FORK
- POMOCNÉ KOLESÁ/TRAINING WHEELS
- NÍZKA HMOTNOSŤ/ONLY 6,9 KG



619-1473



552-1475



ZIGGY RF12



RÁM/FRAME: Kenzel Aluminium

VEĽKOSŤ RÁMU/FRAME SIZE: 17 cm

VEĽKOSŤ KOLIES/WHEEL SIZE: 12"

VIDLICA/FORK: Kenzel Hi-ten

PREDNÝ NÁBOJ/FRONT HUB: Hi-ten

ZADNÝ NÁBOJ/FREEHUB: Hi-ten torpedo

REŤAZ/CHAIN: KMC S1

BRZDY/BRAKES: Saccon V-brake/coaster brake

RÁFIKY/RIMS: RMK REA Color 502

HMOTNOSŤ/WEIGHT: 6,2 kg

527-1472





553-1459



619-1456



ZIGGY RF16



RÁM/FRAME: Kenzel Aluminium

VEĽKOSŤ/SIZE: 21 cm

VEĽKOSŤ KOLIES/WHEEL SIZE: 16"

VIDLICA/FORK: Kenzel Hi-ten

PREDNÝ NÁBOJ/FRONT HUB: Hi-ten

ZADNÝ NÁBOJ/FREEHUB: Hi-ten torpedó

REŤAZ/CHAIN: KMC S1

BRZDY/BRAKES: Saccon V-brake/coaster brake

RÁFIKY/RIMS: RMK REA color 501/502

HMOTNOSŤ/WEIGHT: 8,05 kg



526-1456



- OD/FROM 100 CM
- BEZPEČNÉ/SAFE
- ĽAHKO OVLÁDATEĽNÉ/EASY HANDLING
- ŠPECIÁLNA GEOMETRIA RÁMU/SPECIAL FRAME GEOMETRY
- OCEĽOVÁ VIDLICA/STEEL FORK
- POMOCNÉ KOLESÁ/TRAINING WHEELS
- NÍZKA HMOTNOSŤ/ONLY 8,05 KG





701-1464



535-1465



LIME/LIMA RF16



RÁM/FRAME: Kenzel Hi-ten

VEĽKOSŤ RÁMU/FRAME SIZE: 21,5 cm

VEĽKOSŤ KOLIES/WHEEL SIZE: 16"

VIDLICA/FORK: Kenzel Hi-ten

PREDNÝ NÁBOJ/FRONT HUB: Hi-ten

ZADNÝ NÁBOJ/FREEHUB: Hi-ten torpedo

BRZDY/BRAKES: Saccon V-brake / coaster brake

RÁFIKY/RIMS: RMK REA Color 501/502

HMOTNOSŤ/WEIGHT: 10,04 kg

- OD/FROM 100 CM
- PEVNÝ RÁM/STRONG FRAME
- SPOĽAHLIVÉ BRZDY/RELIABLE BRAKES
- POMOCNÉ KOLESÁ/TRAINING WHEELS INCLUDED

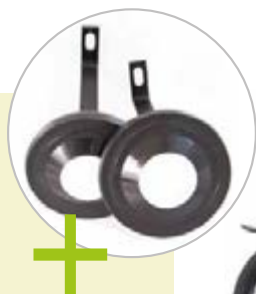

747-1464



619-1464





502-1453

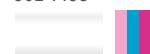

NINA CEREMONY 20 1SPD



RÁM/FRAME: Kenzel Hi-ten
VEĽKOSŤ/SIZE: 31 cm
VEĽKOSŤ KOLIES/WHEEL SIZE: 20"
VIDLICA/FORK: Kenzel Hi-ten
PREDNÝ NÁBOJ/FRONT HUB: Hi-ten

ZADNÝ NÁBOJ/FREEHUB: Hi-ten torpedó
BRZDY/BRAKES: Saccon V-brake/coaster brake
RÁFIKY/RIMS: RMK REA color 502
HMOTNOSŤ/WEIGHT: 10,9 kg



535-1450



True friendship
is like

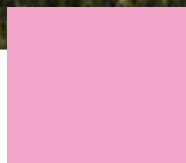

LOOK OUT FOR NEW ADVENTURES





619-1456



535-1458



ZIGGY RF20



RÁM/FRAME: Kenzel aluminium

VEĽKOSŤ/size: 25 cm

VEĽKOSŤ KOLIES/WHEEL SIZE: 20"

VIDLICA/FORK: Kenzel Hi-ten

PREDNÝ NÁBOJ/FRONT HUB: Hi-ten

ZADNÝ NÁBOJ/FREEHUB: Hi-ten torpedo

REŤAZ/CHAIN: KMC S1

BRZDY/BRAKES: Saccon V-brake /coaster brake

RÁFIKY/RIMS: RMK REA Color 501/502

HMOTNOSŤ/WEIGHT: 9,25 kg



701-1456





535-1440



701-1437



KALEO / KALEA RF20



RÁM/FRAME: Kenzel Hi-ten
VEĽKOSŤ RÁMU/FRAME SIZE: 28 cm
VEĽKOSŤ KOLIES/WHEEL SIZE: 20"
VIDLICA/FORK: Kenzel Hi-ten
PREDNÝ NÁBOJ/FRONT HUB: Hi-ten

ZADNÝ NÁBOJ/FREEHUB: Hi-ten torpedo
BRZDY/BRAKES: Saccon V-brake / coaster brake
RÁFIKY/RIMS: RMK REA Color 501/502
HMOTNOSŤ/WEIGHT: 11,3 kg



526-1435



509-1437



502-1439

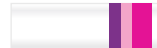



719-1515



WIND SF200



RÁM/FRAME: Kenzel Hi-ten	PREHADZOVAČ/REAR DERAILLEUR: Shimano Tourney RD-FT35
VEĽKOSŤ/size: 32 cm	PREŠMÝKAČ/FRONT DERAILLEUR: Shimano FD-TZ500
VEĽKOSŤ KOLIES/WHEEL SIZE: 20"	REŤAZ/CHAIN: KMC Z7
VIDICA/FORK: Zoom CH327E	PREVODNÍK S KLUKAMI/CRANK SET: Detai Hi-ten 42/34T
PREDNÝ NÁBOJ/FRONT HUB: Hi-ten	KAZETA/FREEWHEEL: Shimano MF-TZ500 6spd
ZADNÝ NÁBOJ/FREEHUB: Hi-ten	BRZDY/BRAKES: Saccon V-brake
RADENIE/SHIFTERS: Shimano Tourney SL-RS35 2x6spd	RÁFIKY/RIMS: RMK SOA Color 501 GBS
	HMOTNOSŤ/WEIGHT 13,3 kg



601-1515



535-1514



TODAY IS A GREAT DAY TO
LEARN SOMETHING **NEW**



DNES JE SKVELÝ DEŇ NA TO,
ABY SOM SA NAUČIL NIEČO **NOVÉ**



619 - 1425



ROXIS SF20



RÁM/FRAME: Kenzel Hi-ten	PREHADZOVAČ/REAR DERAILLEUR: Shimano Tourney RD-TZ500
VEĽKOSŤ/SIZE: 28 cm	REŤAZ/CHAIN: KMC S7
VEĽKOSŤ KOLIES/WHEEL SIZE: 20"	PREVODNÍK S KLUKAMI/CRANK SET: Detai Hi-ten 36T
VIDLICA/FORK: Zoom CH327E	KAZETA/FREEWHEEL: Shimano MF-TZ500 6spd
PREDNÝ NÁBOJ/FRONT HUB: Hi-ten	BRZDY/BRAKES: Saccon V-brake
ZADNÝ NÁBOJ/FREEHUB: Hi-ten	RÁFIKY/RIMS: RMK SOA Color 501/502 GBS
RADENIE/SHIFTERS: Shimano SL-RS35 6spd	HMOTNOSŤ/WEIGHT: 12,9 kg



547-1426



701 - 1425



535-1430



502-1429

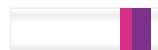



601-656-1443



635-1444



VULCANO 300 SF24



RÁM/FRAME: Kenzel MTB aluminium	PREHADZOVAČ/REAR DERAILLEUR: Shimano Tourney RD-TZ500
VEĽKOSŤ/size: 30 cm	PREŠMÝKAČ/FRONT DERAILLEUR: Shimano Tourney FD-TY500
VEĽKOSŤ KOLIES/WHEEL SIZE: 24"	PREVODNÍK S KLUKAMI/CRANK SET: Prowheel TC-CQ02 42/32/22T
VIDLICA/FORK: ZOOM 565 D	KAZETA/FREEWHEEL: Shimano Acera MF-TZ500 14-28T 7spd
PREDNÝ NÁBOJ/FRONT HUB: Aluminium disc	BRZDY/BRAKES: ZOOM DB-280 mechanical disc
ZADNÝ NÁBOJ/FREEHUB: Aluminium disc	RÁFIKY/RIMS: RMK SOA Color 656/502 Disc
RADENIE/SHIFTERS: Shimano SL-RS36 3x7spd	HMOTNOSŤ/WEIGHT: 13,1 kg



635-1444



601-656-1443



VULCANO 100 SF24



RÁM/FRAME: Kenzel MTB aluminium	PREHADZOVAČ/REAR DERAILLEUR: Shimano Tourney RD-TZ500
VEĽKOSŤ/size: 30 cm	PREŠMÝKAČ/FRONT DERAILLEUR: Shimano Tourney FD-TY500
VEĽKOSŤ KOLIES/WHEEL SIZE: 24"	PREVODNÍK S KLUKAMI/CRANK SET: Prowheel TC-CQ02 42/32/22T
VIDLICA/FORK: ZOOM 565 AMS	KAZETA/FREEWHEEL: Shimano MF-TZ500 6spd
PREDNÝ NÁBOJ/FRONT HUB: Aluminium	BRZDY/BRAKES: Saccon V-brake
ZADNÝ NÁBOJ/FREEHUB: Aluminium	RÁFIKY/RIMS: RMK SOA Color 656/502 GBS
RADENIE/SHIFTERS: Shimano SL-RS36 3x6spd	HMOTNOSŤ/WEIGHT: 13,2 kg



535-1416



RARITY SF24



RÁM/FRAME: Kenzel MTB aluminium

VEĽKOSŤ/size: 34 cm

VEĽKOSŤ KOLIES/WHEEL SIZE: 24"

VIDLICA/FORK: ZOOM 565 AMS

PREDNÝ NÁBOJ/FRONT HUB: Aluminium

ZADNÝ NÁBOJ/FREEHUB: Aluminium

RADENIE/SHIFTERS: Shimano SL-RS35 7spd

PREHADZOVAČ/REAR DERAILLEUR: Shimano Tourney RD-TZ500

PREVODNÍK S KLUKAMI/CRANK SET: Prowheel 36T

KAZETA/FREEWHEEL: Shimano Acera MF-TZ500

BRZDY/BRAKES: Saccon V-brake

RÁFIKY/RIMS: RMK SOA Color 502 GBS

HMOTNOSŤ/WEIGHT: 12,4 kg





556 - 1216



ROXIS SF24



RÁM/FRAME: Kenzel Hi-ten	PREŠMÝKAČ/FRONT DERAILLEUR: Shimano FD-TY300
VEĽKOSŤ/SIZE: 33 cm	REŤAZ/CHAIN: KMC Z7
VEĽKOSŤ KOLIES/WHEEL SIZE: 24"	PREVODNÍK S KLUKAMI/CRANK SET: Detai Hi-ten 42/34/24T
VIDLICA/FORK: ZOOM CH327E	KAZETA/FREEWHEEL: Shimano MF-TZ500 6spd
PREDNÝ NÁBOJ/FRONT HUB: Aluminium	BRZDY/BRAKES: Saccon V-brake
ZADNÝ NÁBOJ/FREEHUB: Aluminium	RÁFIKY/RIMS: RMK SOA Color 501/502 GBS
RADENIE/SHIFTERS: SHIMANO TOURNEY SL-RS36 3x6spd	HMOTNOSŤ/WEIGHT: 14,3 kg
PREHADZOVAČ/REAR DERAILLEUR: Shimano Tourney RD-TZ500	



701-1211



509-1212



535-1217



502-1218

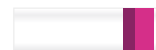



547-1511



WIND SF300



RÁM/FRAME: Kenzel Hi-ten	PREHADZOVAČ/REAR DERAILLEUR: Shimano Tourney RD-TZ500
VEĽKOSŤ/SIZE: 36 cm	PREŠMÝKAČ/FRONT DERAILLEUR: Shimano FD-TY300
VEĽKOSŤ KOLIES/WHEEL SIZE: 24"	REŤAZ/CHAIN: KMC Z7
VIDLICA/FORK: ZOOM CH327E	PREVODNÍK S KLUKAMI/CRANK SET: Detai Hi-ten 42/34/24T
PREDNÝ NÁBOJ/FRONT HUB: Hi-ten	KAZETA/FREEWHEEL: Shimano MF-TZ500 6spd
ZADNÝ NÁBOJ/FREEHUB: Hi-ten	BRZDY/BRAKES: Saccon V-brake
RADENIE/SHIFTERS: Shimano Tourney SL-RS36 3x6spd	RÁFIKY/RIMS: RMK SOA Color 501 GBS
	HMOTNOSŤ/WEIGHT: 14,8 kg



509-1512



719-1511



701-1511



535-1514





719-1235



AXEL SF24



RÁM/FRAME: Kenzel Hi-ten full suspension	PREHADZOVAČ/REAR DERAILLEUR: Shimano Tourney RD-TZ500
VELKOSŤ RÁMU/FRAME SIZE: 43 cm	PREŠMÝKAČ/FRONT DERAILLEUR: Shimano FD-TZ500
VELKOSŤ KOLIES/WHEEL SIZE: 24"	REŤAZ/CHAIN: KMC Z7
VIDLICA/FORK: ZOOM CH327E	KLUKY/CRANK SET: Detai Hi-ten 42/34/24T
PREDNÝ NÁBOJ/FRONT HUB: Hi-ten	KAZETA/FREEWHEEL: Shimano MF-TZ500 6spd
ZADNÝ NÁBOJ/FREEHUB: Hi-ten	BRZDY/BRAKES: Saccon V-brake
RADENIE/SHIFTERS: Shimano Tourney SL-RS35 3x6spd	RÁFIKY/RIMS: RMK SOA Color 501 GBS
	HMOTNOSŤ/WEIGHT: 15,8 kg



701-525-1235



656-1235





535-1418



701-1417



YUM! RF24



RÁM/FRAME: Kenzel Hi-ten	PREŠMÝKAČ/FRONT DERAILLEUR: Shimano FD-TY300
VEĽKOSŤ/SIZE: 38 cm	REŤAZ/CHAIN: KMC Z7
VEĽKOSŤ KOLIES/WHEEL SIZE: 24"	PREVODNÍK S KLUKAMI/CRANK SET: Detai Hi-ten 42/34/24T
VIDLICA/FORK: Kenzel Hi-ten	KAZETA/FREEWHEEL: Shimano MF-TZ500 6spd
PREDNÝ NÁBOJ/FRONT HUB: Aluminium	BRZDY/BRAKES: Saccon V-brake
ZADNÝ NÁBOJ/FREEHUB: Aluminium	RÁFIKY/RIMS: RMK SOA Color GBS
RADENIE/SHIFTERS: Shimano Tourney SL-RS36 3x6spd	HMOTNOSŤ/WEIGHT: 13,6 kg
PREHADZOVAČ/REAR DERAILLEUR: Shimano Tourney RD-TZ500	



514-1419



502-1419

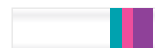



519-1184



535-1200



COMPACT RF24



RÁM/FRAME: Kenzel MTB Hi-ten	PREŠMÝKAČ/FRONT DERAILLEUR: Gilong QLD-01
VELKOSŤ/size: 38 cm	REŤAZ/CHAIN: KMC Z6
VELKOSŤ KOLIES/WHEEL SIZE: 24"	PREVODNÍK S KLUKAMI/CRANK SET: Detai Hi-ten 42/34/24T
VIDLICA/FORK: Kenzel Hi-ten	KAZETA/FREEWHEEL: QLF-06 6spd
PREDNÝ NÁBOJ/FRONT HUB: Hi-ten	BRZDY/BRAKES: Saccon V-brake
ZADNÝ NÁBOJ/FREEHUB: Hi-ten	RÁFIKY/RIMS: RMK REA Natural
RADENIE/SHIFTERS: Gilong QLK-01	HMOTNOSŤ/WEIGHT: 14,4 kg
PREHADZOVAČ/REAR DERAILLEUR: Gilong QLB-04	



747-1189



601-1184



514-1199



502-1198

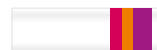



601-1141

SHADE SF26 JUNIOR

26" 6061 T6 ALU HLO HD3 EKO

RÁM/FRAME: Kenzel MTB Aluminium

VEĽKOSŤ RÁMU/FRAME SIZE: 13"/15"

VEĽKOSŤ KOLIES/WHEEL SIZE: 26"

VIDLICA/FORK: SR SUNTOUR XCM

PREDNÝ NÁBOJ/FRONT HUB: Aluminium disc

ZADNÝ NÁBOJ/FREEHUB: Aluminium disc

RADENIE/SHIFTERS: Shimano ST-EF500 3x7spd

PREHADZOVAČ/REAR DERAILLEUR: Shimano Tourney RD-TZ500

PREŠMÝKAČ/FRONT DERAILLEUR: Shimano FD-TY500

REŤAZ/CHAIN: KMC Z7

PREVODNÍK S KLUKAMI/CRANK SET: Prowheel TA-CM68 24/34/42T

KAZETA/FREEWHEEL: Shimano MF-TZ500 7spd

BRZDY/BRAKES: ZOOM DB-280

RÁFIKY/RIMS: RMK SOA Color

HĽADNOSŤ/WEIGHT: 15 kg



657-1138



656-1138





601-1117

CALIBRE 400



RÁM/FRAME: Kenzel Road K-light Aluminium	PREŠMÝKAČ/FRONT DERAILLEUR: Shimano Tourney FD-A070
VEĽKOSŤ RÁMU/FRAME SIZE: 48/50 cm	REŤAZ/CHAIN: KMC Z7
VIDLIČKA/FORK: Road Aluminium tapered	KLUKY /CRANK SET: Shimano Tourney FC-A070 50/34T
PREDNÝ NÁBOJ/FRONT HUB: Aluminium	KAZETA/FREEWHEEL: Shimano Tourney CS-HG200-7 12-28T
ZADNÝ NÁBOJ/FREEHUB: Aluminium	BRZDY/BRAKES: RC-462 caliper
RADENIE/SHIFTERS: Shimano Tourney A070 2x7spd	RÁFIKY/RIMS: RMX RCX Black GBS
PREHADZOVAČ/REAR DERAILLEUR: Shimano Tourney RD-A070	HMOTNOSŤ/WEIGHT: 10,5 kg

DO YOU HAVE AT HOME A SMALL CYCLIST WHO WOULD RATHER PREFER YOUR ROAD BIKE? NO PROBLEM. CALIBRE 400 JUNIOR INSPIRED BY OUR ADULT MODELS IS A PERFECT CHOICE FOR YOUNG BEGINNERS.

MÁTE DOMA MALÉHO CYKLISTU, KTORÝ BY SI NAJRADŠEJ PRIVLASTNIL VÁŠ CESTNÝ BICYKEL? ŽIADNY PROBLÉM. PRE VŠETKÝCH ZAČÍNAJÚCICH JAZDCOV JE TU NÁŠ CESTNÝ BICYKEL CALIBRE 400 JUNIOR INŠPIROVANÝ NAŠIMI MODELMI PRE DOSPELÝCH.

MINI RETRO EDITION

MINI RETRO EDITION BIKES ARE STYLISH BIKES YOUR MINI RIDERS WILL LOVE. FEATURING COLOUR-MATCHED MUDGUARDS AND FULL CHAIN GUARD ARE ALSO VERY PRACTICAL. HAND-MADE IN SMALL BATCHES, A SEMI-GLOSS PAINT FINISH, ERGONOMIC BROWN GRIPS, TRAINING WHEELS AND A COMFY „MADE IN ITALY“ SADDLE. IT ALSO COMES WITH A CUTE BASKET. CHILDREN CAN BRING THEIR CUDDLY TOYS WHEREVER THEY GO AND STORE ALL THE DISCOVERIES COLLECTED DURING THEIR EXPEDITIONS. THE ADJUSTABLE SADDLE AND HANDLEBAR WITH STEM ADAPT YOUR GROWING CHILD.

- STYLISH RETRO CHARM
- FOR CHILDREN FROM 3-5 YEARS
- INFLATABLE WHEELS
- ADJUSTABLE HANDLEBAR AND SADDLE
- DEVELOPS CHILDREN'S MOTOR SKILL



- KRÁSNE RETRO PREVEDENIE
- VHODNÉ PRE DETI OD 3 DO 5 ROKOV
- NAFUKOVACIE KOLESÁ
- POHODLNE NASTAVITEĽNÁ VÝŠKA SEDLA A RIADIDIEL

MINI RETRO EDÍCIA

BICYKLE Z MINI RETRO EDÍCIE SÚ ŠTÝLOVÉ BICYKLE, KTORÉ SI MINI JAZDCI HNEĎ OBLÚBIA. VĎAKA FAREBNE ZLADENÝM BLATNÍKOM A CELOKRYTOM REŤAZE SÚ TIEŽ VEĽMI PRAKTICKÉ. SÚ RUČNE VYRÁBANÉ V MALÝCH SÉRIÁCH, MÁJÚ POLOLESKLÝ NÁTER, SÚ VYBAVENÉ ELEGANTNÝMI HNEDÝMI RUKOVÄŤAMI, POMOCNÝMI KOLEŠAMI A POHODLNÝM SEDLOM VYROBENÝM V TALIANSKU. VĎAKA KOŠÍKU SI DETI MÔŽU VZIAŤ AJ SVOJE HRAČKY VŠADE SO SEBOU. SEDLO A RIADIDLÁ JE MOŽNÉ PRISPÔSOBIŤ VÝŠKE VÁŠHO RASTÚCEHO DIEŤAŤA.



BICYCLES ALSO HAVE A CUTE BASKET WHERE KIDS CAN CARRY THEIR TOYS ON THE GO.

BICYKLE MAJÚ AJ ROZTOMILÝ KOŠÍK, V KTOROM MÔŽU DETIČKY PREVÁŽAŤ SVOJE HRAČKY NA CESTÁCH.

NEW
NOVINKA



558-1462



LIMA 16 CEREMONY 1SPD



RÁM/FRAME: Kenzel Hi-ten	ZADNÝ NÁBOJ/FREEHUB: Hi-ten torpedo
VEĽKOSŤ RÁMU/FRAME SIZE: 21,5 cm	BRZDY/BRAKES: Saccon V-brake / coaster brake
VEĽKOSŤ KOLIES/WHEEL SIZE: 16"	RÁFIKY/RIMS: RMK REA Natural
VIDLICA/FORK: Kenzel Hi-ten	HĽADNOSŤ/WEIGHT: 10,04 kg
PREDNÝ NÁBOJ/FRONT HUB: Hi-ten	



- OD/FROM 100 CM
- PEVNÝ RÁM/STRONG FRAME
- SPOĽAHLIVÉ BRZDY/RELIABLE BRAKES
- POMOCNÉ KOLESÁ/TRAINING WHEELS INCLUDED

SUMMER IS HERE





FEATURING A BASKET THAT MAY BE DETACHED AND REATTACHED USING A HOOK.



502-1520



LUNA 16 CEREMONY 1SPD



RÁM/FRAME: Kenzel Hi-ten	ZADNÝ NÁBOJ/FREEHUB: Hi-ten torpedo
VEĽKOSŤ/size: 26 cm	BRZDY/BRAKES: Saccon V-brake/coaster brake
VEĽKOSŤ KOLIES/WHEEL SIZE: 16"	RÁFIKY/RIMS: RMK REA Natural
VIDLICA/FORK: Kenzel Hi-ten	HMOTNOSŤ/WEIGHT: 9,4 kg
PREDNÝ NÁBOJ/FRONT HUB: Hi-ten	



INCLUDED

558-1520





ZMRZLINA ZÁBAVA FOTO



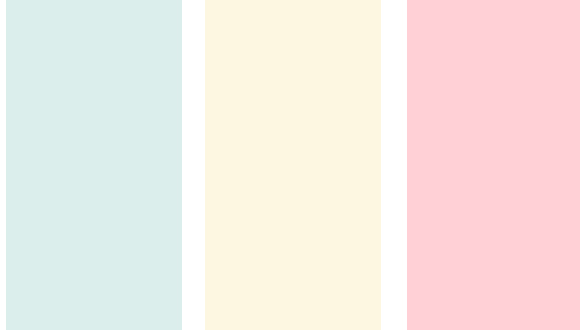

BICYCLES ALSO HAVE A CUTE BASKET WHERE KIDS CAN CARRY THEIR TOYS ON THE GO.

BICYKLE MAJÚ AJ ROZTOMILÝ KOŠÍK, V KTOROM MÔŽU DETIČKY PREVÁŽAŤ SVOJE HRAČKY NA CESTÁCH.



502-1500

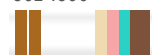

BELLA 20 ROYAL

6SPD



RÁM/FRAME: Kenzel Hi-ten

VEĽKOSŤ/size: 31 cm

VEĽKOSŤ KOLIES/WHEEL SIZE: 20"

VIDLICA/FORK: Kenzel Hi-ten

PREDNÝ NÁBOJ/FRONT HUB: Hi-ten

ZADNÝ NÁBOJ/FREEHUB: Hi-ten torpedo

BRZDY/BRAKES: Saccon V-brake/coaster brake

RÁFIKY/RIMS: RMK SOA Natural

HMOTNOSŤ/WEIGHT: 12,5 kg



559-1500



914-1500



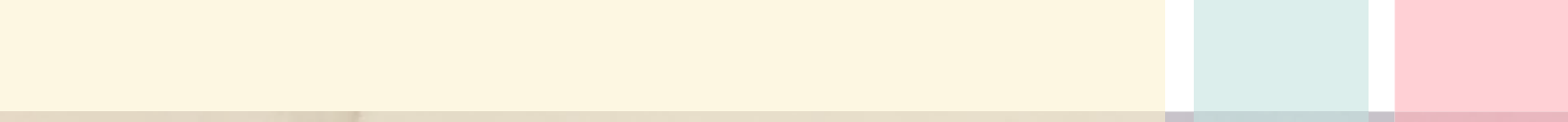

be . you . tiful



KIDS RETRO EDITION



914-1460



BELLA 24 ROYAL 6SPD



RÁM/FRAME: Kenzel Hi-ten	PREHADZOVAČ/REAR DERAILLEUR: Shimano Tourney RD-TZ500
VEĽKOSŤ/SIZE: 33 cm	REŤAZ/CHAIN: KMC Z7
VEĽKOSŤ KOLIES/WHEEL SIZE: 24"	PREVODNÍK S KLUKAMI/CRANK SET: Hi-ten 42T
VIDLICA/FORK: Kenzel Hi-ten	KAZETA/FREEWHEEL: Shimano MF-TZ500 6spd
PREDNÝ NÁBOJ/FRONT HUB: Aluminium	BRZDY/BRAKES: Saccon V-brake
ZADNÝ NÁBOJ/FREEHUB: Aluminium	RÁFIKY/RIMS: RMK SOA Natural
RADENIE/SHIFTERS: Shimano SL-RS35 6spd	HMOTNOSŤ/WEIGHT: 14,7 kg



936-1460



502-1460



503-1460





502-1584

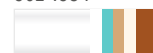

ATLANTIS 24 CEREMONY 1SPD



RÁM/FRAME: Kenzel cruiser Hi-ten

VEĽKOSŤ RÁMU/FRAME SIZE: 36 cm

VEĽKOSŤ KOLIES/WHEEL SIZE: 24"

VIDLICA/FORK: Kenzel Hi-ten

PREDNÝ NÁBOJ/FRONT HUB: Hi-ten

ZADNÝ NÁBOJ/FREEHUB: Hi-ten torpedo

BRZDY/BRAKES: Saccon V-brake / coaster brake

RÁFIKY/RIMS: RMK SOA Natural

HMOTNOSŤ/WEIGHT: 15,2 kg



503-1584





MOM

DAUGHTER

SQUAD





**EQUIPMENT
ACCESSORIES
VÝBAVA/DOPLNKY**

APPAREL/OBLEČENIE

ALTERIA MEN SJ

MEN'S CYCLING JERSEY / PÁNSKY DRES

BLACK-GR-SIL

700 004 M
700 004 L
700 004 XL
700 004 XXL



CHIMERA-BLUEBERRY

-WR

700 006 M
700 006 L
700 006 XL
700 006 XXL



BLACK-SIL

700 008 M
700 008 L
700 008 XL
700 008 XXL



BLUEBERRY-NGR-WH

700 010 M
700 010 L
700 010 XL
700 010 XXL



ALTERIA MEN STBP

MEN'S SPORT BIB SHORTS WITH PAD
PÁNSKE NOHAVICE KRÁTKE S TRAKMI A VLOŽKOU

BLACK-GR-SIL

700 005 M
700 005 L
700 005 XL
700 005 XXL



CHIMERA-BLUEBERRY-WR

700 007 M
700 007 L
700 007 XL
700 007 XXL



BLACK-SIL

700 009 M
700 009 L
700 009 XL
700 009 XXL



BLUEBERRY-NGR-WH

700 011 M
700 011 L
700 011 XL
700 011 XXL



► HIGH-QUALITY ITALIAN FABRIC

ALTERIA WOMAN SJ

LADIES CYCLING JERSEY / DÁMSKY DRES

BEIGE-WH-B

700 002 S
700 002 M
700 002 L



BLACK-WH

700 003 S
700 003 M
700 003 L



BLUEBERRY-NGR6044

700 012 S
700 012 M
700 012 L

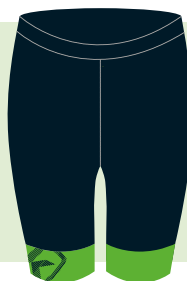

700 013 S
700 013 M
700 013 L



ALTERIA WOMAN STWP

LADIES CYCLING SHORTS WITHOUT PAD
DÁMSKE NOHAVICE KRÁTKE BEZ VLOŽKY

BLACK-WH

700 014 S
700 014 M
700 014 L
700 014 xL



700 015 S
700 015 M
700 015 L
700 015 xL



CARAIBI-WH

700 016 XS
700 016 S
700 016 M
700 016 L
700 016 XL

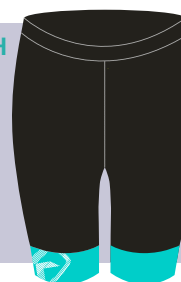

700 017 XS
700 017 S
700 017 M
700 017 L
700 017 XL



REFINED ELEGANCE
AND FUNCTIONALITY

LIGHTS / OSVETLENIE

WHETHER IT'S COMMUTING THROUGH A CITY OR HEADING OUT ON THE MOUNTAIN BIKE AT NIGHT, OUR RANGE OF BIKE LIGHTS ARE SURE TO KEEP YOUR PATH ILLUMINATED AND YOU VISIBLE.

ČI UŽ IDE O JAZDU MESTOM ALEBO JAZDU NA HORSKOM BICYKLI V NOCI, NAŠA PONUKA SVETIEL NA BICYKLE VÁM ZARUČÍ, ŽE VAŠA CESTA BUDE OSVETLENÁ.

FRONT LIGHT / PREDNÉ SVETLÁ



RMK SCUTTI

FRONT LIGHT
PREDNÉ SVETLO

1W high quality Cree LED
Functions: 100% Brightness - 50% Brightness - Off
Off Low battery indicator
Packaging: AM

1W vysoko kvalitné biele Cree LED
Funkcie: 100% jas - 50% jas - vypnuté
S indikátorom výdrže batérie
Balenie: AM

600 105-221117-7036 SCUTTI



RMK ZIGGI

ALUMINIUM FRONT LIGHT
PREDNÉ HLINÍKOVÉ SVETLO

3W white LED
Functions: Flash-Steady-Off
Waterproof structure design
Packaging: AM

3W biela LED dióda
Funkcie: blikanie/stále svietenie/
vypnuté
Vodeodolný dizajn
Balenie: AM

600 106-221118-2463 ZIGGI



RMK SATURN

FRONT LIGHT
PREDNÉ SVETLO

5 LED
Functions: Flash-Steady-Off
Fit for handlebar diameter 22,2-25,4 mm
Packaging: AM

5 LED
Funkcie: blikanie/stále svietenie/
vypnuté
Na riaditka s priemerom 22,2-25,4 mm
Balenie: AM

600 109-221116-370F SATURN



RMK OMEGA

FRONT FORK LIGHT
PREDNÉ SVETLO NA VIDLICU

1 LED
Functions: Flash-Steady-Off
Packaging: OEM

1 LED
Funkcie: blikanie/stále svietenie/
vypnuté
Balenie: OEM

600 107-7019 OMEGA



RMK TRUMP

FRONT FORK LIGHT
PREDNÉ SVETLO NA VIDLICU

1W LED
Functions: Flash-Steady-Off
Packaging: OEM

1W LED
Funkcie: blikanie/stále svietenie/
vypnuté
Balenie: OEM

600 108-7008 TRUMP



RMK RETRO

FRONT FORK LIGHT
PREDNÉ SVETLO

3 LED
Functions: ON/Off
Packaging: OEM

3 LED
Funkcie: ON/OFF
Balenie: OEM

600 103-592 chrome
600 104-592 white/biele



RMK RETRO

FRONT FORK LIGHT
PREDNÉ SVETLO

3 LED
Functions: ON/Off
Packaging: OEM

3 LED
Funkcie: ON/OFF
Balenie: OEM

600 102-592 black/čierne



spanninga SWINGO

FRONT LIGHT
PREDNÉ SVETLO

1 Super bright white LED
Autonomy: 40 h
Functions: ON/Off
Packaging: OEM

1 Super jasná biela LED
Výdrž: 40h
Funkcie: ON/OFF
Balenie: OEM

600 110 SWINGO



ANLUN RETRO

FRONT DYNAMO LIGHT
PREDNÉ SVETLO NA DYNAMO

with outside pole
steel
6 V / 2,4 W
Packaging: OEM

osvetlenie na dynamo
6 V / 2,4 W
Balenie: OEM

600 111 ANLUN RETRO



CITY

FRONT FORK LIGHT
PREDNÉ SVETLO

3 LED
Functions: ON/Off
Packaging: OEM

3 LED
Funkcie: ON/OFF
Balenie: OEM

600 101-7102 CITY

REAR LIGHT / ZADNÉ SVETLÁ



RMK
TERGO

REAR LIGHT
ZADNÉ SVETLO

3 LED
Functions: Flash-Steady-Off
Fit for seat post diameter 25,4 - 31,8 mm
Packaging: AM

3 LED
Funkcie: blikanie/stále svietenie/vypnuté
Na sedlovú trúbku s priemerom 22,2-25,4 mm. Súčasťou je aj držiak na sedlovú trúbku.
Balenie: AM

600 404-221115-289T TERGO



RMK
IGNIS

REAR LIGHT
ZADNÉ SVETLO

0,5W Bright LEDs
Functions: Steady light- Flashing - Gradual flashing
Fit for seat post diameter of 25,4 mm - 31,8 mm, waterproof
Packaging: AM

0,5W Extrasvietivé LED diódy
Funkcie: stále svietenie, blikanie, postupné blikanie
Na sedlovú trúbku s priemerom 25,4 - 31,8 mm, vodeodolné
Balenie: AM

600 405-221109-528 IGNIS



RMK
ALLANI

CARRIER LIGHT
ZADNÉ SVETLO NA NOSIČ

3 LED
Function: On-Off
With reflector
80mm or 50mm carrier fit mount
Packaging: OEM

3 LED
Funkcie: zapnuté-vypnuté
S reflektorom
Kompatibilný na zadný nosič s miestom na svetlo s rozmerom 80mm alebo 50mm
Balenie: OEM

600 406-535 ALLANI



RMK
APOLLO

CARRIER LIGHT
ZADNÉ SVETLO NA NOSIČ

3 LED
Function: On-Off
Packaging: OEM

3 červené LED
Funkcie: zapnuté-vypnuté.
Balenie: OEM

600 402-221050 APOLLO 270



spanninga
NR.9

REAR FENDER LIGHT
ZADNÉ SVETLO NA BLATNÍK

LED technology - 5 Candela
Autonomy: 120 h
Function: On-Off
Packaging: OEM

technológia LED - 5 Candela
Výdrž: 120h
Funkcie: zapnuté-vypnuté.
Balenie: OEM

600 403 NR.9



RMK
RIO

REAR FENDER LIGHT
ZADNÉ SVETLO NA BLATNÍK

3 LED
Function: On-Off
Low battery indicator
Packaging: OEM

3 LED
Funkcie: zapnuté-vypnuté
Indikátor vybitia batérie
Balenie: OEM

600 408-6151 RIO



RMK
CANIS

REAR FENDER LIGHT
ZADNÉ SVETLO NA BLATNÍK

1 LED
Functions:
Flash-Off
Packaging: OEM

1 LED
Funkcie: zapnuté-vypnuté
Balenie: OEM

600 407-591 CANIS 591

SETS LIGHT / SADY SVETIEL



RMK
SIMO

600 701-808289 SIMO

Predné svetlo s výkonnými 5 extrasvietivými bielymi LED diódami, svietivosťou 12 LUX a tromi funkciami (blikanie, svietenie, postupné svietenie), ideálne na riadítka s priemerom 22,2mm a 25,4mm. Zadné svetlo vybavené tromi extrasvietivými červenými LED diódami s tromi funkciami (blikanie, svietenie a postupné svietenie), vhodné na rozmer 25,4mm a 31,8mm.

Front light with powerful 5 bright white LEDs with the intensity 12 LUX and three functions (flashing, lighting, gradual flashing) , perfect for handlebar with a diameter of 22.2 mm and 25.4 mm. Rear light with high intensity three red LEDs with three functions (flashing, lighting and gradual flashing), suitable for the size of 25.4 mm and 31.8 mm.

BRACKETS / DRŽIAKY



FRONT LIGHT BRACKET 1"
DRŽIAK OSVETLENIA 1"

600 003-520T silver/strieborne



FRONT LIGHT BRACKET
DRŽIAK OSVETLENIA

600 001 black/čierne
600 002 silver/strieborne



TOTTI

Set of waterproof silicone front and rear lights with two high-light LEDs.
Two functions - flashing, steady.

Sada vodeodolného silikónového predného a zadného svetla s dvoma vysokosvietivými LED diódami. Vhodné na všetky typy bicyklov.
Dve funkcie - blikanie a stále svietenie.



600 703-2672 red/červené
600 702-2672 black/čierne
600 704-2672 blue/modré
600 705-2672 green/zelené

FRONT SEATS TILL AGE OF 3 / PREDNÉ SEDAČKY DO VEKU 3 ROKOV

Bobike MINI bicycle safety seats for the front of your bike are suitable for children ages 9 months (or when they can sit up by themselves) till 3 years or 15 kilograms. Dutch Design & Made in Europe.

Detské sedačky Bobike MINI sú vhodné pre deti vo veku od 9 mesiacov (alebo v prípade, že dokážu sedieť sami) do 3 rokov alebo 15 kilogramov. Holandský dizajn. Vyrobené v Európe.



9 - 15 kg



9 months to 3 years
9 mesiacov až 3 roky



standard Ø 22 to 32 mm
MTB 1/1"8

BOBIKE GO MINI

406 055-8012400004
Cotton candy pink



THE GO MINI IS A TRENDY BICYCLE SAFETY SEAT IN PASTEL COLOURS FOR THE FRONT OF THE BIKE. The GO mini features a double-walled construction made of sturdy plastic and a body wrapping design with armrests for extra safety. The three-point belt can be operated with one hand and closes in a solid 'Easy-Click' buckle. The cushion is comfortable, easy to clean and completely waterproof. The footrests can be adjusted in height without the use of any tools.

GO MINI JE MODERNÁ SEDAČKA V PASTELOVÝCH FARBÁCH NA PREDNÚ ČASŤ BICYKLA. GO mini má dvojstennú konštrukciu z odolného plastu a telo s podrúčkami pre vyššiu bezpečnosť. Trojbodový pás sa dá ovládať jednou rukou a zatvára sa do pevnej spony „Easy-Click“. Podložka je pohodlná, ľahko sa čistí a je úplne vodotesná. Stupačky možno výškovo nastaviť bez použitia akéhokoľvek náradia.

Weight / Hmotnosť:
2760 g



406 054-8012400003
Marshmallow mint



406 056-8012400005
Macaron grey



406 057-8012400002
Vanilla cupcake

WINDSCREEN

The protective one / Jednotka v ochrane

PREDNÝ ŠTÍT NA DETSKÚ SEDAČKU KOMPATIBILNÝ S BOBIKE ONE MINI A BOBIKE GO MINI SEDAČKOU.



406 012-8015500003
Urban grey



406 011-8015500001
Urban black



406 062-8015500012
Coffee brown



406 010-8015500004
Chocolate brown



406 060-8015500006
Strawberry Red



406 061-8015500002
Snow white

Weight / Hmotnosť:
912 g

Weight / Hmotnosť:
2705 g

BOBIKE ONE MINI

THE BOBIKE ONE LETS YOU AND YOUR CHILD(REN) EXPLORE THE CITY BY BIKE IN A SAFE AND UNIQUE WAY.

BOBIKE ONE VÁM A VÁŠMU DIEŤAŤU UMOŽNÍ PRESKÚMAŤ MESTO NA BICYKLI BEZPEČNÝM A JEDINEČNÝM SPÔSOBOM.

- Comfortable, waterproof and shock absorbing
- EVA cushion
- Soft and comfortable shoulder pads
- 2-point adjustable seatbelt
- Adjustable footrests, no tools needed
- Assembly key included.

- Pohodlné, vodotesné a tlmiace nárazy
- Podložka na sedenie
- Mäkká a pohodlná ramenná ochrana na pásy
- 2-bodový nastaviteľný bezpečnostný pás
- Nastaviteľné stupačky bez použitia náradia
- Montážny kľúč súčasťou



406 040-801200004
Chocolate brown



406 045-801200002
Snow white



406 039-801200012
Coffee brown



406 043-801200001
Urban black



406 058-801200006
Strawberry red



406 044-801200003
Urban grey



406 042-801200008
Olive green

MIX & MATCH



Bobike ONE Mini - olive green



Bobike Plus Dino



Bobike ONE - olive green



Bobike ONE Mini + Windscreen
GO - Chocolate Brown



Bobike one Plus
chocolate brown



Bobike ONE - Chocolate Brown
+ IP Mounting Set



BOBIKE EXCLUSIVE MINI

THE BOBIKE EXCLUSIVE MINI IS THE PERFECT CHOICE FOR LONGER TRIPS. THE SEAT FEATURES A UNIQUE CONTOURED SAFETY BELT SYSTEM THAT CLOSSES IN THE BACK OF THE SEAT. THE SYSTEM KEEPS YOUR BABY IN AN UPRIGHT POSITION, EVEN WHEN THEY FALL ASLEEP. THE SMALL HANDLEBAR ON THE FRONT SEAT LETS YOUR BABY ACTIVELY PARTICIPATE.

406 038-8011000019
Denim deluxe



BOBIKE EXCLUSIVE MINI JE IDEÁLNOU VOĽBOU NA DLHŠIE CESTY. SEDADLO MÁ UNIKÁTNY TVAROVANÝ BEZPEČNOSTNÝ PÁSOVÝ SYSTÉM, KTORÝ SA ZAKLIKÁVA DO ZADNEJ ČASTI SEDADLA. SEDAČKA JE STAVANÁ TAK, ABY VAŠE DIEŤA OSTA-
LO VO VZPRIAMENEJ POLOHE, AJ KEĎ ZASPÍ. MALÉ RIADITKO NA SEDAČKE UMOŽŇUJE DIEŤAŤU AKTÍVNE SA ZÚČASTNIŤ CESTY. K SEDAČKE JE MOŽNÉ SI DOKÚPIŤ OPIERKU HLAVY.

Weight / Hmotnosť:
2500 g



406 034-8011000018
Cinnamon brown



406 035-8011000017
Safari chic



406 037-8011000020
Urban grey



406 036-8011000016
Urban black

EXCLUSIVE WINDSCREEN

THERE'S NO SUCH A THING AS BAD WEATHER...

...only poor preparation. Protect your baby against wind, sun and rain with a windscreen that matches your Bobike mini. The transparent screen is sturdy and shock proof. It has a sleek design and is available in a color to match your Bobike seat. The screen is installed and removed in no-time at all.

NIE JE NIČ TAKÉ AKO ZLÉ POČASIE ...

... len zlá príprava. Chráňte svoje dieťa pred vetrom, slnkom a dažďom s čelným sklom. Priehľadná plastová ochrana je pevná a odolná voči nárazom. Má elegantný dizajn a je k dispozícii vo farbách, ktoré zodpovedá ku kolekcií Bobike exclusive mini.



406 007-8015200014
Safari chic

Weight / Hmotnosť:
780 g



406 009-8015200015
Cinnamon brown



406 008-8015200013
Urban black



406 059-8015200016
Denim deluxe

MIX & MATCH



Bobike Exclusive Mini
+ Windscreen Exclusive
- Cinnamon brown

KENZEL Bellissima

Bobike Exclusive Mini
+ Windscreen Exclusive
- Urban Grey

Bobike City helmet
- Urban Grey

Bobike ONE XS helmet
- Urban Grey

Bobike Exclusive Maxi
- Urban Grey
+ IP Mounting Set

KENZEL Bellissima

REAR SEATS TILL AGE OF 5 / ZADNÉ SEDAČKY DO 5 ROKOV

Bobike bicycle safety seats for the back of your bike are suitable for children till the age of 5 years or with a body weight not exceeding 22 kilograms.

Sedačky Bobike Maxi sú vhodné pre deti do 5 rokov alebo do dosiahnutia telesnej hmotnosti nepresahujúcou 22 kilogramov.

bobike
bicycle safety seats



9 to 22 kg



Ø 28 to 40 mm



CLICK & GO



ONE SYSTEM FITS ALL



FOR CARRIER (E-BD) CLICK&GO MOUNTING SYSTEM - CLICK&GO SYSTÉM S UPEVNENÍM NA ZADNÝ NOSIČ (E-BD)



ONE SYSTEM FITS ALL FOR FRAMES AND CARRIERS (1P&E-BD) - JEDEN SYSTÉM, KTORÝ OBSAHUJE ÚCHYT NA ZADNÝ NOSIČ AJ NA RÁM (1P&E-BD)



9 months to 5 years
9 mesiacov až 5 rokov



120 to 185 mm



e-bike fitting

VÝHODNÁ CENA

THE BOBIKE GO IS THE SLEEK AND STYLISH DUTCH DESIGN INTEGRATED INTO AN INCREASED PROTECTIVE EXPANDED SHELL. Just like all other Bobike safety seats, the GO features a double-walled shell. The GO is an easy to use safety seat that is perfect for a versatile family that is ready to tackle the daily commute. No tools are needed in the assembly process.

BOBIKE GO S ELEGANTNÝM A ŠTÝLOVÝM HOLANDSKÝM DIZAJNOM JE INTEGROVANÝ DO VYVÝŠENEJ OCHRANNEJ KONŠTRUKCIE. Rovnako ako všetky ostatné sedačky Bobike, aj GO má dvojstennú konštrukciu. GO je ľahko použiteľná sedačka, ktorá je ideálna pre všestrannú rodinu na každodenný dojazd. Na montáž nie sú potrebné žiadne nástroje.

Weight / Hmotnosť:
3215 g

BOBIKE GO

Create the best memories / Vytvorte najlepšie spomienky

406 026-8012300003
Marshmallow mint

406 027-8012300002
Vanilla cupcake

406 023-8012300004
Cotton candy pink

406 025-8012300005
Macaron grey

BOBIKE ONE MAXI

406 063-8012100006
Strawberry Red

406 063-8015300145
1P Mounting Set



406 029-8012100012
Coffee Brown



406 033-8012100003
Urban grey



406 031-8012100002
Snow white



406 028-8012100004
Chocolate Brown



406 032-8012100001
Urban Black

Weight / Hmotnosť:
3280 g

The Bobike Exclusive is especially designed for parents who like to go outdoors with their children. Enjoying nature, feeling the wind blow through your hair, enjoying the sunshine on your face. Taking the bike to go visit the grandparents. And should the trip take too long, the unique belt system keeps your child in an upright position when it falls asleep. The exclusive, award-winning design blends in perfectly with the current bike trends. But it is not just a beautiful design, it is above all a very practical design.

Bobike Exclusive je špeciálne navrhnutý pre rodičov, ktorí radi trávia voľný čas so svojimi deťmi vonku. Vychutnajte si prírodu, cítte vietor vo vlasoch a užívajte si slnko. A ak cesta trvá príliš dlho, unikátny systém pásu udržiava dieťa vo vzpriamenej polohe keď zaspí. Exkluzívny, oceňovaný dizajn sa dokonale hodí k súčasným trendom. Ale nie je to len krásny dizajn, je to predovšetkým veľmi praktický dizajn ktorý získal ocenenie IF Design Award.

BOBIKE EXCLUSIVE MAXI

406 020-8011200019
Safari chic



Weight / Hmotnosť:
3305 g

- Double-walled seat for extra safety
- EASY assembly
- Unique seatbelt system keeps your child in an upright position
- Adjustable footrests, no tools needed
- Integrated spoke shielding
- Soft, water-repellant cushion
- Integrated combination lock
- Suitable for all bikes with a carrier incl. e-bikes
- Made in Europe

- Dvojstenná sedačka pre mimoriadnu bezpečnosť
- Nastaviteľná opierka hlavy
- Ľahká montáž Click & Go
- Unikátny systém bezpečnostných pásov udržiava dieťa vo vzpriamenej polohe
- Nastaviteľné opierky na nohy, nie sú potrebné žiadne nástroje
- Mäkká podložka odpuďzuje vodu
- Integrovaný kombinovaný zámok
- Vhodné pre všetky bicykle s nosičom vrátane e-bikov
- Vyrobené v Európe



406 018-8011200020
Cinnamon brown



406 019-8011200021
Denim deluxe



406 021-8011200018
Urban black



406 022-8011200022
Urban grey

BOBIKE EXCLUSIVE MAXI TOUR

406 015-8011400033
Urban black



grows with your child
10 cm
extra comfort for the child

rastie s vaším dieťaťom
10 cm
extra komfort

Weight / Hmotnosť:
4070 g

The Bobike Exclusive Tour is suitable for children between 9 and 22 kg. It is placed on the bicycle by the saddle on the carrier using a simple adapter.

Detská cyklosedačka Bobike Exclusive Tour je vhodná pre deti s hmotnosťou od 9 do 22 kg. Umiestňuje sa na bicykel za sedlo na nosič pomocou jednoduchého adaptéra.



406 014-8011400035
Cinnamon brown



406 013-8011400034
Safari chic



406 016-8011400037
Urban grey



BOBIKE CLASSIC JUNIOR

The supporting seat for children ages 5 to 10 years.
Podporné sedadlo pre deti vo veku od 5 do 10 rokov.

The Classic Junior offers support for children that are old enough to sit independently on the back of your bike but cannot quite cover longer distances by themselves. The lap belt avoids them from standing up. The seat offers a handy bag bracket and when not in use, the seat folds down and can be used as an object carrier. The Bobike Junior can carry a weight up to 35 kilograms.

Weight / Hmotnosť:
4335 g

Classic Junior ponúka podporu pre deti, ktoré sú dostatočne staré na to, aby sedeli samostatne na zadom nosiči bicykla. Brušný pás im bráni vstať zo sedačky. Sedačku je možné sklopiť keď sa nepoužíva, zadná opierka sa sklopí a dá sa použiť ako nosič na predmety. Bobike Junior môže uniesť hmotnosť až 35 kilogramov.

406 017-801050001
Urban black

The Bobike Classic Junior is not suitable for e-bikes with a battery under the rear rack.

Bobike Classic Junior nie je vhodný pre bicykle s batériou v zadnom nosiči.



BOBIKE ACCESSORIES



406 003-8015300145
1P Mounting Set

The solution for bikes without a carrier. If you want to mount a Bobike seat with EASY mount but your bike does not have a carrier, or if your carrier is not compatible, the 1 Point Mounting Set is your solution. You mount it to the saddle tube of your bike and it will fit frames with round tubes with a diameter between Ø 28-40 mm and is suitable for 26" and 28" bikes.

Riešenie pre bicykle bez nosiča. Ak chcete namontovať Bobike sedačku s EASY mountom, ale váš bicykel nemá nosič, alebo ak váš nosič nie je kompatibilný, 1 bodová montážna sada je riešením. Namontujete ho podsedlovú trúbku vášho bicykla a je vhodný na rámy s okrúhlymi trúbkami s priemerom medzi 28-40 mm a je vhodný pre 26 "a 28" bicykle.

IT'S ALL ABOUT THE BASE

Bobike's EASY mounting system ensures super quick installation and makes it a breeze to place the seat on a different bike. The EASY mounting system fits on carriers with a width of 120 - 175mm and a tube diameter between 10-16mm (round tubes only) and was especially designed to fit on both e-bikes and regular bicycles.

Montážny systém Bobike EASY zaisťuje super rýchlu inštaláciu sedačky ak si plánujete často prehadzovať sedačku z jedného bicykla na druhý. Montážny systém EASY sa hodí na nosiče so šírkou 120 - 175 mm a priemerom rúry medzi 10-16 mm (len kruhové rúry) a bol špeciálne navrhnutý tak, aby sa zmontoval aj na elektrobicykle.



406 006-8015300053
E-bike Luggage Carrier - EASY Mounting System



406 005-8015300043
Universal bracket Bobike mini

This mounting bracket is already included when you purchase a Bobike mini seat. If you want an additional bracket or need a replacement, this is the spare part you need. This bracket fits standard steering tubes Ø 22-28mm and MTB bikes steering tubes: 1-1/8".

Tento montážny držiak je už pri kúpe mini sedačky Bobike súčasťou balenia. Ak plánujete strieďať jednu mini sedačku na viacerých bicykloch práve tento náhradný diel potrebujete pre zrýchlenú montáž -mini sedačku stačí len zakliknúť. Tento držiak je vhodný pre štandardné rozmery trúbiek Ø 22-28mm a pre MTB bicykle 1-1/8".



400 004-8015300139
A-Head Adapter

With this bracket you can easily mount a Bobike safety seat on a bike with A-Headset. An adjustable stem remains usable and the display or controller of an electric bike can also stay in place. The required installation space is only 4mm.

S týmto držiakom môžete ľahko namontovať sedačku Bobike na bicykel s A-Head predstavcom. Požadovaný inštalčný priestor je len 4 mm.





FOR CHILD 9-15KG PRE DETI 9-15KG	●			●			●													
FOR CHILD 9-22KG PRE DETI 9-22KG		●	●		●	●			●	●	●	●								
FOR CHILD 22-35KG PRE DETI 22-35KG																				●
To place on the front Head Tube (ø22-32mm) Umiestnenie na hlavovú rúrku (ø22-32mm)	●			●					●											
To place on the seat tube (ø28 -40mm) Umiestnenie na sedlovku (ø28 -40mm)		●			●						●		●							
To place on the seat tube (ø28 -50mm) Umiestnenie na sedlovku (ø28 -50mm)																				●
To place on the carrier (120-185mm/120-175mm) Umiestnenie na nosič (120 - 185 mm / 120 - 175 mm)			●			●				●	●	●	●	●	●	●				
Matching Windscreen available K dispozícii čelné sklo	●			●					●											
Matching Helmet available K dispozícii helma	●	●	●	●	●	●	●	●	●	●	●	●	●	●	●	●	●	●	●	●
Double-Walled safety Dvojitá ochrana	●	●	●	●	●	●	●	●	●	●	●	●	●	●	●	●	●	●	●	●
Increased Head Protection Zvýšená ochrana hlavy		●	●						●				●	●						
Ease of assembly (1 = super easy, 5 requires a bit of work) Jednoduchá montáž (1 = super ľahké, 5 vyžaduje trochu práce)	2	2	1	2	4	3	2	4	3	4	3	5								
Adjustable Foot Rests Nastavitelné opierky nôh	●	●	●	●	●	●	●	●	●	●	●	●	●	●	●	●	●	●	●	●
Safety Back Reflector Bezpečnostný reflektor		●	●		●	●			●	●	●	●	●	●	●	●	●	●	●	●
Safety Led Light Bezpečnostné LED svetlo														●	●					
Possibility to place the belt in different height positions Možnosť umiestnenia pásu v rôznych výškových polohách		●	●						●	●	●	●	●	●	●	●	●	●	●	●
TÜV approval Schválenie TÜV	●	●	●	●	●	●	●	●	●	●	●	●	●	●	●	●	●	●	●	●

Awards
Ocenenia

Awarded with Good Industrial Design in 2015. Awarded with the Gut Label by Stiftung warentest (2,3).

V roku 2015 získal ocenenie Good Industrial Design. Ocenený Gut Labelst Stiftung warentest (2,3).

Awarded with Good Industrial Design in 2015.

V roku 2015 získal ocenenie Good Industrial Design.

Best tested by the Dutch Consumer Organization. Awarded Best Buy by the Dutch Consumer Organization.

Výherca testu holandskej spotrebiteľskej organizácie. Ocenený Best Buy holandskou organizáciou spotrebiteľov.

AN ERGONOMIC BACKREST WITH AN INTEGRATED HELMET SLOT TO ENSURE MAXIMUM COMFORT AND SUPPORT TO THE CHILD'S BACK AND NECK, HEIGHT-LENGTH-DEPTH-ADJUSTABLE SAFETY BELTS AND A VERY SOFT SEAT PAD.

ERGONOMICKÉ OPERADLO S INTEGROVANÝM OTVOROM PRE PRILBU ZARUČUJE MAXIMÁLNE POHODLIE A PODPORU CHRBTU A KRKU DIEŤAŤA, VÝŠKOVO NASTAVITELNÉ BEZPEČNOSTNÉ PÁSY A VEĽMI MÄKKÁ PODLOŽKA.

- Lightweight and strong frame made with non-toxic, easy-to-wash plastic
- Soft washable cushion
- Parent-friendly safety buckle, it can be fastened and unfastened with just one hand and is adjustable in dept
- Footrests are fully adjustable in height
- Safety straps can be adjusted in height and length
- High sides to better contain your child
- Large foot guards to prevent contact with the spokes of the wheels
- Integrated helmet slot

CLAMP SYSTEM

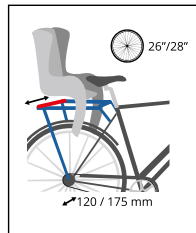

- *Lahký a pevný rám vyrobený z netoxického, ľahko umývateľného plastu*
- *Mäkká umývateľná poduška*
- *Rodičovská bezpečnostná pracka, môže byť upevnená a rozopnutá len jednou rukou a je nastaviteľná v priestore*
- *Stupačky sú výškovo nastaviteľné*
- *Bezpečnostné pásy je možné nastaviť na výšku a na dĺžku*
- *Vysoké boky na zvýšenie detskej opory a ochrany*
- *Veľké ochranné kryty nôh na zabránenie kontaktu s kolesami*
- *Integrovaný otvor pre helmu*

406 064-01 FXSB0025M
BEIGE VINTAGE



ŠTANDARDNÉ BALENIE/STANDARD



B-FIX SYSTEM

406 066-01 BFIX 00

B-Fix is a patented anchoring device to fix the child carrier under the handlebar or on the bike frame under the saddle. The only anchoring system in the world to mount either front and rear carriers. Integrated lock/unlock device. B-Fix easily adapts to very classic frames as well as to most modern design frames.

Bellelli B-Fix je patentované zariadenie na upevnenie detskej sedačky pod riaditkú alebo na rám bicykla pod sedlom. Jediný kotviaci systém na svete, ktorý umožní uchytenie sedačky aj vprednej aj vzadnej časti bicykla. Integrované zariadenie na uzamknutie / odomknutie sedačky. B-Fix sa ľahko prispôsobí klasickým rámom ako aj najmodernejším diazajnovým rámom.

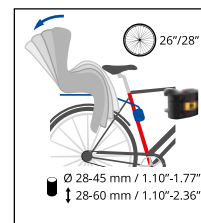

- Non-toxic certified plastic frame, lightweight, resistant and washable
- Soft washable cushion
- Ventilation holes located at shoulders and back
- Childproof, parent-friendly safety buckle, with two depth settings in the center of the seat. Only one hand is needed to fasten and release it
- Broad footrests height settings range: 15 cm – 5.9" (13 positions)
- Three-point height/length - adjustable harness. Three shoulders height slots
- Comfortable, spacious seat area
- High sideboards to increase child support and containment
- Ample legs/feet side protection to avoid any contacts with wheel spokes

CLAMP SYSTEM

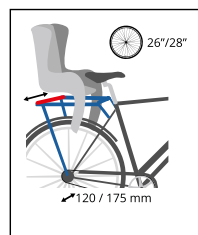

- *Netoxický certifikovaný plastový rám, ľahký, odolný a umývateľný*
- *Mäkká umývateľná poduška*
- *Ventilačné otvory umiestnené na ramenách a chrbte*
- *Detská bezpečnostná pracka, s dvoma nastaveniami hlĺbky v strede sedadla*
- *Na upevnenie a uvoľnenie je potrebná iba jedna ruka*
- *Rozsah stupňov nastavenia dráhy: 15 cm - 5,9 "(13 polôh)*
- *Trojbodové nastavenie výšky/dĺžky*
- *Pohodlné, priestranné sedadlo*
- *Vysoké boky na zvýšenie detskej opory a ochrany*
- *Veľké ochranné kryty nôh na zabránenie kontaktu s kolesami*

406 065-01 PPS00001
DARK GREY

ŠTANDARDNÉ BALENIE/STANDARD



STANDARD MULTI-FIX SYSTEM

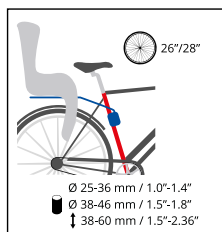

- Steel made anchoring system for rear-mounted child bicycle carriers. Fits to circular section frames and to a wide range of modern and elliptical section frames.
- *Oceľový systém uchytenia pre detské zadné sedačky, vhodné pre rámy kruhového tvaru a širokú škálu moderných rámov s nepravidelnými tvarmi.*

EXTRA DOPLNOK/BUY EXTRA

MULTIFIX SYSTEM

406 067-01 UFS 10001

HELMETS / PRILBY



BOBIKE CITY



702 006-8741300001
Cream M
702 005-8741300004
Cream L

702 008-8741300002
Urban grey M
702 007-8741300003
Urban grey L

BOBIKE CITY HELMET IS A TRENDY, COMPACT AND LIGHTWEIGHT HELMET FOR YOU TO MANEUVER THROUGH THE CITY WITH EASE AND A LOT OF STYLE. THE CREAM AND URBAN GREY COLORS WILL MATCH ANY OUTFIT AND A WIDE RANGE OF CITY BIKES.

With a removable visor, a bug net, a chin pad protector, thermoformed set of inner paddings (extra set included) the Bobike CITY helmet will deliver you comfortable safety. The Bobike City helmet has 10 vents to help keep you cool, and a back safety reflective sticker to increase rider visibility on the road.

PRILBA BOBIKE CITY JE MODERNÁ, KOMPAKTNÁ A LAHKÁ PRILBA, KTORÁ VÁM UMOŽNÍ LAHKO A ŠTÝLOVO MANÉVROVAŤ CEZ MESTO. KRÉMOVÉ A MESTSKÉ ŠEDÉ FARBY SA HODIA K AKÉMKUOLVEK OBLEČENIU A ŠIROKEJ ŠKÁLE MESTSKÝCH BICYKLOV.

S odnímateľným štítom, vnútornou sieťkou, tepelne tvarovanou sadou vnútorných vložiek (extra sada zahrnutá) prilba Bobike CITY vám prinesie pohodlnú bezpečnosť. Prilba Bobike City má 10 vetracích otvorov a reflexnú nálepku na zvýšenie viditeľnosti jazdca na ceste.

Size / Veľkosť:
M (53-56 cm)
L (56-61 cm)

Weight / Hmotnosť:
Size / veľkosť M: 285 g
Size / veľkosť L: 300 g

PROTECT YOUR BABY WITH A HELMET TO MATCH THEIR SEAT

CHRÁŇTE DIEŤA PRILBOU, KTORÁ ZODPOVEDÁ ICH SEDAČKE

BOBIKE EXCLUSIVE PLUS

The fancy Exclusive seat has now a high-end helmet to match the look. With an in-mold construction, this colored matte model features an increased back safety protection, along with safety reflective stickers in order to increase the child visibility on the road. With 17 vents to help keep your child's head cool. The helmet also features a bug net to keep your child safe from flying insects. The comfortable DIAL system and the thermoformed inner paddings will increase the fitting and the comfort for every day use.

Size / Veľkosť: S (52-56cm)
Weight / Hmotnosť: 205 g

Tento farebný matný in-mold model má zvýšenú bezpečnostnú ochranu konštrukcie spolu s bezpečnostnými reflexnými nálepkami, aby sa zvýšila viditeľnosť dieťaťa na ceste. So 17 vetracími otvormi, ktoré pomáhajú udržať hlavu dieťaťa v pohode. Prilba tiež obsahuje bug sieť, aby bolo vaše dieťa v bezpečí pred lietajúcim hmyzom. Pohodlný DIAL systém a termoformované vnútorné vypchávkavy zvýšia príhľadnosť a pohodlie pre každodenné použitie.



702 047-8740300044
Denim deluxe



702 048-8740300047
Urban grey



702 049-8740300046
Cinnamon brown



702 050-8740300045 Safari chic

BRIGHTEN UP THE STREETS WITH THE COLORS OF THE ONE

BOBIKE ONE PLUS

The colorful matte helmets feature an in-mold construction and an expanded protective area to increase safety. The adjustable dial retention system ensures a perfect fit. The chin straps are soft and lock in a 3 point safety harness. Two rear reflective decals increase visibility when it gets dark out. A bug net will keep your child safe from flying insects and 10 cooling vents keep your child's head cool.

Farebné matné prilby sú in-mold a majú rozšírenú ochrannú plochu na zvýšenie bezpečnosti. Desať vetracích otvorov udržuje hlavu vášho dieťaťa v pohode a jemná sieťka poskytuje ochranu proti lietajúcemu hmyzu. Systém Easy-Lock vám umožňuje ľahko nastaviť prilbu na správnu veľkosť a reflexné prvky zabezpečia, že vaše dieťa je za tmy viditeľné.

Size / Veľkosť:
XS (48-52 cm)
S (52-56 cm)

Weight / Hmotnosť:
Size / veľkosť M: 285 g
Size / veľkosť L: 300 g

ROZJASNITE ULICE S FARBAMI ONE



702 029-8740800008 white XS
702 028-8740900008 white S



702 032-8740800010 Urban grey XS
702 031-8740900010 Urban grey S



702 022-8740800005 coffee brown XS
702 021-8740900005 coffee brown S



702 024-8740800007 brown XS
702 023-8740900007 brown S



702 046-8740800009 Strawberry red XS
702 030-8740900009 Strawberry red S

BOBIKE PLUS XS

With an in-mold construction, this model features increased back safety protection. Reflective safety decals increase the child's visibility on the road. The helmet is available in 3 different graphic designs which will match your baby's imagination. Multiple vents keep your baby cool and the integrated bug net protects your baby from flying insects. The slim DIAL system and the thermoformed inner paddings will increase fit and comfort.



702 044-874020038
Teddy bear XS

Size / Veľkosť: XS (48-53cm)
Weight / Hmotnosť: 185 g



702 003-874020039
Ballerina XS



702 001-874020037
Ahoy XS

BOBIKE PLUS S

S konštrukciou in-mold je tento model vybavený zvýšenou ochranou chrbta. Reflexné bezpečnostné štítky zvyšujú viditeľnosť dieťaťa na ceste. Prilba je k dispozícii v 3 rôznych grafických prevedeniach, ktoré zodpovedajú vašej detskej predstavivosti. Viacnásobné ventilačné otvory udržiavajú vaše dieťa v pohode a integrovaná sieťka chráni vaše dieťa pred lietajúcim hmyzom. Tenký systém DIAL a vnútorné výplne s tepelným tvarovaním zvýšia príľnavosť a pohodlie.



702 009-874030033
Dino S



702 020-874030034
Navy stars S



702 042-874030035
Pinky zebra S



Size / Veľkosť: S (52-56cm)
Weight / Hmotnosť: 205 g

BOBIKE GO



OFFER YOUR BABY EXTRA PROTECTION WITH A HELMET THAT PERFECTLY MATCHES THE GO® SAFETY SEATS. The Go Helmet, features nine vents to keep your baby's head cool and a bug net that provides protection against flying insects. The Easy-Lock system lets you easily adjust the helmet to the correct size and, the reflective decals make sure your baby is visible when it is dark out.

702 015-874020042
Marshmallow mint XS
702 014-874030038
Marshmallow mint S

DOPRAJTE SVOJMU DIEŤAŤU DODATOČNÚ OCHRANU PRILBOU, KTORÁ DOKONALE LADÍ K SEDÁČKAM GO® a k našim bicyklom. Deväť vetracích otvorov udržia hlavu vášho dieťaťa v pohode a jemná sieťka poskytuje ochranu proti lietajúcemu hmyzu. Systém Easy-Lock vám umožňuje ľahko nastaviť prilbu na správnu veľkosť a reflexné prvky zabezpečia, že vaše dieťa je za tmy viditeľné.

702 011-874020043
Cotton candy pink XS
702 010-874030039
Cotton candy pink S

Weight / Hmotnosť: Size / veľkosť XS: 230g XS (46-53 cm)
Size / veľkosť S: 235 g S (52-56 cm)



BASKETS / KOŠÍKY



FRONT BASKET WITH HANDLEBAR MOUNT FR-HB

PREDNÝ KOŠÍK S ÚCHYOM NA RIADITKA FR-HB

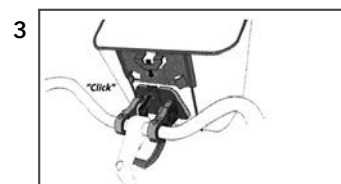
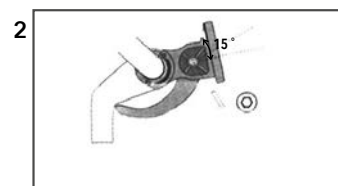
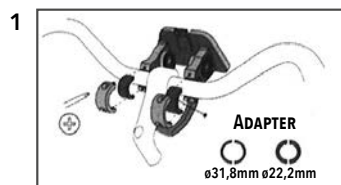

FRONT BASKET WITH HANDLEBAR STEM MOUNT FR-HS

PREDNÝ KOŠÍK S ÚCHYOM NA PRED-STAVEC FR-HS

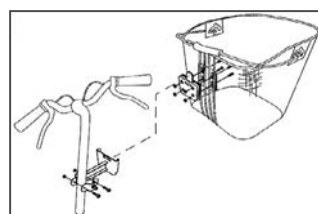

REAR BASKET R-HB

ZADNÝ KOŠÍK S ÚCHYOM NA NOSIČ R-HB

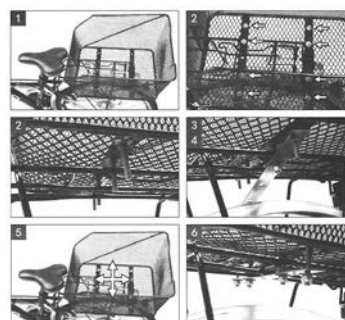

DEFINITION / VYSVETLIVKY:

- 1** bez adaptéra - potrebné dokúpiť bez adaptéra - potrebné dokúpiť
 2 s adaptérom - (klik systém) s adaptérom - (klik systém)
 3 pevný systém pevný systém
 4 bez systému upevnenia bez systému upevnenia
 5 násuvný systém násuvný systém



THE STYLISH TEXTILE BASKET HAS A UNIQUE ALUMINIUM FRAME WITH COUPLING. The Bikebasket is a fine shopping companion.

ŠTÝLOVÝ TEXTILNÝ KOŠÍK MÁ UNIKÁTNY HLINÍKOVÝ RÁM SO SPOJKOU. Tento košík je skvelý spoločník na nákupy.



Size / Veľkosť: 34x27x22 cm

BASKET FABRIC FR-HB

- aluminium frame
- waterproof fabric
- two internal and one external pocket

- hliníkový rám
- vodotesná tkanina
- dve vnútorné a jedno vonkajšie vrecko

588160122 BROWN/HNEDÝ

588160123 VIOLET/FIALOVÝ



BASKET CUBIS FR-HB

Size / Veľkosť: 35x25x25 cm

HT-262 BROWN-WHITE/HNEDO-BIELY

ARE YOU PLANNING A TRIP TO THE SUPERMARKET? ACCENT SHOPPING BASKET, WHICH IS SUITABLE FOR SHOPPING, BASKET BASIL RATAN LOOK IS AN EXCELLENT CHOICE. DO YOU NEED SOMETHING TO GO TO AND FROM THE OFFICE DAILY? THIS BASKET IS AN EXCELLENT CHOICE.

PLÁNUJETE VÝLET DO SUPERMARKETU? AK HĽADÁTE KOŠÍK NA BICYKEL, KTORÝ PONÚKA POHODLNÉ ULOŽENIE VÁŠHO NÁKUPU, KOŠÍK BASIL RATAN LOOK JE VYNIKAJÚCOU VOĽBOU.



1

BASIL BREMEN WICKER

The Basil Bremen Wicker is a classic choice of bicycle basket. Basket is made from natural materials with a lacquered finish. Easily attached to your handlestem.

Prútený Basil Bremen wicker je klasickou voľbou. Košík je vyrobený z prírodných materiálov s lakovaným povrchom. Lahko sa montuje na predstavec.

Size / Veľkosť: 39x29x29 cm

13078 WICKER/PRÚTIE



1

BASIL BREMEN RATAN LOOK

- Synthetic rattan
- Weatherproof basket
- Easily attached to the front of your bike

- Umelý ratan
- Kôš odolný voči poveternostným vplyvom
- Lahko pripevnený k prednej časti bicykla

19033 GREY/SIVÝ

19037 SEAGRASS/MORSKÁ TRÁVA

19038 NATURE BROWN/PRIRODNÁ HNEDÁ

Size / Veľkosť: 27x35x29 cm



EREMES WICKER FR-HB

- with quick release bracket to handlebar
- compatible with standard and oversize handlebars

- s držiakom na riadidlách
- kompatibilné so štandardnými a nadrozmerými riadidlami

Size / Veľkosť: 36x26x22 cm

588160297 HNEDÝ/BROWN

588160290 PRÍRODNÝ/NATURAL



2

MARIGOLD WICKER FR-HS

Size / Veľkosť: 42x26,5x28,5 cm

RW002 WICKER/PRÚTIE



2

BASKET SWAN FR-HB

waterproof synthetic rattan, removable, height adjustable basket, natural brown

vodeodolný syntetický ratan, odnímateľný

Size / Veľkosť: 35x25x26/22 cm

PW001 NATURE BROWN/PRIRODNÁ HNEDÁ

GR001 SEAGRASS/MORSKÁ TRÁVA

- very firm and high quality design
- plastic covered ergonomic handle
- fine meshed steel net

- veľmi pevný a vysoko kvalitný dizajn
- plastová ergonomická rukoväť
- jemná ocelová sieťovina



BASKET M-WAVE

Size / Veľkosť: 35x25x25 cm

43510 BLACK/ČIERNY



2

PEONY FR-HB

Size / Veľkosť: 34,5x25x26 cm

Q014 BLACK/ČIERNY

Q016 WHITE/BIELY



2

WATSON FR-HS

Size / Veľkosť: 31x23x22,5/20 cm

WG013 BLACK/ČIERNY



BASIL FLOWER

- Fits lengthways on the luggage carrier
- Easily attached with supplied mounting set.
- Weatherproof

- Montuje sa na nosič
- Ľahko pripevnený s dodanou montážnou sadou.
- Odolný proti poveternostným vplyvom

Size / Veľkosť: 45x31x21 cm

11175 BLACK/ČIERNY
11176 PINK/RUŽOVÝ
11187 WHITE/BIELY

BASIL CENTO

The Basil Cento Basket is a more modern choice of bicycle storage. Designed with fixed mounting in mind, it attaches securely to any luggage carrier.

Basil Cento Basket je modernejšou voľbou. Navrhnuté s pevnou montážou, bezpečne sa pripája k akémukoľvek nosiču batožiny.

Size / Veľkosť: 45x31x21 cm

11186 WHITE/BIELY

BASKET SWAN REAR

127009 NATURE BROWN/PRÍRODNÁ HNEDÁ



BASIL FLOWER S

Size / Veľkosť: 36x26x18 cm

11178 BLACK/ČIERNY

THIS BASIL CENTO RATTAN LOOK BICYCLE BASKET IS A STYLISH CHOICE OF STORAGE FOR CYCLISTS AND ATTACHES EASILY TO THE REAR OF YOUR BIKE.



BASIL CENTO RATTAN LOOK JE ŠTYLOVÝ KOŠÍK Z UMELEHO RATANU S VEĽKÝM ÚLOŽNÝM PRIESTOROM ĽAHO PŘIPEVNITELNÝ K ZADNEJ ČASTI VÁŠHO BICYKLA.

BASIL CENTO RATAN LOOK

Suitable for fixed installation at the rear of your bike. Waterproof
Maximum carrying weight of 5 kg (approx)

Vhodné pre pevnú inštaláciu na zadný nosič
Vodeodolný
Maximálna nosnosť 5 kg (cca).

- 20008 GREY/SIVÝ**
- 20018 SEAGRASS/MORSKÁ TRÁVA**
- 20007 NATURE BROWN/PRÍRODNÁ HNEDÁ**

Size / Veľkosť: 47x34x22 cm

PHLOX R-HB

Size / Veľkosť: 45x30x22 cm

- PW007 NATURE BROWN/PRÍRODNÁ HNEDÁ**
- GR003 SEAGRASS/MORSKÁ TRÁVA**

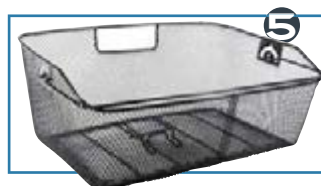

DORRIS

Size / Veľkosť: 50x25x20 cm

- 431545 BLACK/ČIERNY**



TREVOR R-HB

Size / Veľkosť: 44x33x22 cm

- R005 BLACK/ČIERNY**

FLORIAN R-HB

Size / Veľkosť: 38x30x18 cm

- HG009 BLACK/ČIERNY**
- HG000 WHITE/BIELY**



KOŠÍK MALÝ

- 127002 BLACK/ČIERNY**



KOŠÍK OVÁL

- 127001 BLACK/ČIERNY**

KOŠÍK VEĽKÝ

- 127004 BLACK/ČIERNY**



BASIL DORSET

Size / Veľkosť: 41x28x22 cm

13050 GREY/SIVÝ
13048 BROWN/HNEDÝ

Luxury rattan with faux leather storage. Suitable for use with all styles of bikes

Luxusný ratan s umelou kožou. Vhodné pre všetky typy bicyklov

BASIL DENTON

Size / Veľkosť: 41x29x25 cm

- 13046 GREY/SIVÝ**
- 13044 BROWN/HNEDÝ**



BASKET COVERS / POŤAHY DO KOŠÍKA

THIS AWESOME BICYCLE BASKET LINER IS THE ULTIMATE BIKE ACCESSORY. TENTO ÚŽASNÝ POŤAH DO KOŠÍKA JE DOKONALÝM DOPLNKOM VÁŠHO BICYKLA.



OVAL



588169052 ROSE FLOWER/RUŽOVÉ KVETY
588169051 NATURAL FLOWER/KVETY
588169050 PRIRODNÝ/NATURAL



RECTANGLE



588169042 ROSE FLOWER/RUŽOVÉ KVETY
588169041 NATURAL FLOWER/KVETY
588169040 PRIRODNÝ /NATURAL

PET BIKE CARRIERS / PRE DOMÁČICH MILÁČIKOV



DO YOU WANT SAFELY DRIVE YOUR PET ON YOUR BIKE?

CHCETE BEZPEČNE VOZIŤ VÁŠHO MILÁČIKA NA SVOJOM BICYKLI?

A basket with a quick clip to the handlebars on a bicycle. There is a safety belt and a pillow in the basket. The basket has 2 front pockets. Maximum load: 7 kg

Košík s jednoduchým pripínaním k riadidlám na bicykli. V košíku je bezpečnostný pás a vankúš. Prepravka má 2 predné vrecká. Maximálne zaťaženie: 7kg

Peggy is a sturdy plastic carrier for pets, designed to be mounted behind the bicycle. Maximum load: 15 kg

Peggy je robustný plastový nosič pre domáce zvieratá, určený na montáž na nosič. Maximálne zaťaženie: 15kg



ATLAS BIKE 10 RAPID

Size / Veľkosť: 41x31x31 cm
73021599W1

ATLAS BIKE 20 RAPID

Size / Veľkosť: 47x35,5x 34,5 cm
73021299W1



PET BOX PEGGY

GREY-GREEN/SIVÝ-ZELENÝ
 Size / Veľkosť: 55x32x22 cm



PET BOX PLUTO

Pluto is a sturdy plastic carrier for pets, designed to be mounted in the front part of the bicycle frame. Maximum load: 10 kg

Bellelli Pluto je robustný plastový nosič pre domáce zvieratá, určený na montáž do prednej časti rámu bicykla. Maximálne zaťaženie: 10 kg

GREY/SIVÝ



Size / Veľkosť: 48x33x19 cm



WICKER BA PET

Handmade wicker basket for pets. Made of natural wicker, covered with high quality steel wire.

Ručne vyrábaný prútený kôš pre domáce zvieratá. Vyrobené z prírodného prútia, kryt z kvalitného ocelového drôtu.

Size / Veľkosť: 14/22x29,5x43 cm

431604 WICKER/ PRÚTIE

YOUR CHILD WILL LOVE THESE COLOURFUL LITTLE BASKETS WHICH CAN BE USED ON A BIKE TO CARRY THEIR SPECIAL TREASURES OR EVERY-DAY ITEMS

*Little baskets,
Big smiles!*

VAŠE DIEŤA BUDE MILOVAŤ TIETO FAREBNÉ MALÉ KOŠÍKY, V KTORÝCH SI NA BICYKLI MÔŽE NIEST' SVOJE ŠPECIÁLNE POKLADY ALEBO PREDMETY KAŽDO-DENNEJ POTREBY.

*Malé košíky
Veľké úsmievy!*



BASIL BOW-TIE

Size / Velkosť: 28x20x19 cm
30132 MINT/MENTOLOVÝ



BASIL BUTTERFLY

Size / Velkosť: 28x20x19 cm
30133 WHITE/BIELY
30134 LILA/SVETLOFIALOVÝ



BASIL BABOUSHKA

Size / Velkosť: 28x20x18 cm
30124 PINK/RUŽOVÝ



BASIL JASMIN

Size / Velkosť: 26x17x17 cm
30109 ROSA - YELLOW/RUŽA - ŽLTÝ
30110 FARM - RED/FARMA - ČERVENÝ



BASIL FLOWER

Size / Velkosť: 26x16x15 cm
30069 LILAC/FIALOVÝ
30069 RED-PINK/RUŽOVÝ



BASIL TORONTO

Size / Velkosť: 26x21x20 cm
30001 BLACK/ČIERNY



BASKET POPPY

Size / Velkosť: 23x16x14 cm
T010 BLACK/ČIERNY
WHITE/BIELY



BASKET KID WIRE

Size / Velkosť: 25x25x15 cm
588160025 PINK/RUŽOVÝ
588160023 WHITE/BIELY



BASKET CHICCO

400 050 BLACK/ČIERNY



BASKET KIDS

127006 WHITE-PINK/BIELO-RUŽOVÝ
WHITE-BLUE/BIELO-MODRÝ



BASKET DAISY

Size / Velkosť: 25,5x17,5x16 cm
T001 PINK/RUŽOVÝ



BASKET CHICCA

HL-BS02-11 WHITE-PINK/BIELO-RUŽOVÝ



BASKET KID VINTAGE

HL-BS03-11 BROWN/HNEDÝ

WHETHER YOU GO TO WORK, SHOP OR JUST GO CYCLING, ONLY WITH BAGS THAT ARE STYLISH AND PRACTICAL.

The style collection bags

Štylova kolekcia tašiek

ČI UŽ IDETE DO PRÁCE, NAKUPOVAŤ ALEBO LEN PRE RADOSŤ BICYKLOVAŤ, TAK JEDINE S TAŠKAMI, KTORÉ SÚ ŠTYLOVÉ A PRAKTICKÉ.



Size / Veľkosť: 39x18x35 cm

17690 BLACKBERRY
17689 PASTEL POWDERS

THE MAGNOLIA DOUBLE BAG BY BASIL COMES WITH A NEW, TRENDY MAGNOLIA DESIGN. A REAL EYE-CATCHER IN GREY EVERYDAY LIFE!

MAGNOLIA DOUBLE BAG OD FIRMY BASIL PRICHÁDZA S NOVÝM MÓDNYM DIZAJNOM MAGNOLIA. OŽIVENIE V KAŽDODENNOM ŽIVOTE!

Constructed from durable polyester, this bag is also waterproof, keeping contents dry should you chance upon rain. Reflective trims enhance your visibility at night, keeping you in clear view of other road users.

Táto taška je vyrobená z odolného polyesteru a je vodotesná, jej obsah zostane suchý počas dažďa. Reflexné líšty zvyšujú vašu viditeľnosť v noci.

- total capacity of 35 litres.
- attaches to your luggage carrier using the Universal Bridge system
- Perfect for e-bike models
- celková kapacita 35 litrov.
- pripája sa k nosiču batožiny pomocou systému Universal Bridge.
- Ideálne pre modely e-bike.

BIKE BAG OR HANDBAG? WHY NOT BOTH AT THE SAME TIME? WITH THE BASIL CARRY ALL BAG WOMEN'S BIKE BAG YOU HAVE GOT A TRUE ALLROUNDER WITH YOU. VERSATILE, STYLISH AND ABSOLUTELY ELEGANT – YOU WILL LOVE TO TAKE IT ALONG EVERYWHERE FROM NOW ON.

CYKLISTICKÁ TAŠKA ALEBO KABELKA? PREČO NIE OBE NARAZ? S DÁMSKOU CYKLISTICKOU TAŠKOU BASIL CARRY ALL BAG MÁTE SKUTOČNÉHO ALLROUNDERA. VŠESTRANNÝ, ŠTYLOVÝ A ABSOLÚTNE ELEGANTNÝ – ODTERAZ SI HO BUDETE CHCIEŤ VZIAŤ SO SEBOU.



17645 BOHEME JADE
17647 BOHEME VINTAGE RED
17519 BLOOM SCARLET RED

Size / Veľkosť: 35x15x31 cm, 18 l

- Bike and shoulder bag made of water-repellent polyester
- Complex synthetic leather details
- Large inner compartment
- Front compartment
- Easy-to-use zip
- Comfortable carrying strap
- Detachable shoulder strap
- Lined inside
- Double reflective strip
- HOOK ON-SYSTEM

- Taška na bicykel a ramená z vodoodpudivého polyesteru
- Komplexné detaily syntetickej kože
- Veľké vnútorné oddelenie
- Predný priestor
- Jednoduchý zips
- Pohodlný nosný popruh
- Odnímateľný ramenný popruh
- Vnútri
- Dvojitý reflexný prúžok
- HOOK ON-SYSTÉM



Size / Veľkosť: 31x1 x23 cm, 11 l

17690 BLOOM GARDENIA WHITE
17569 BLOOM SCARLET RED

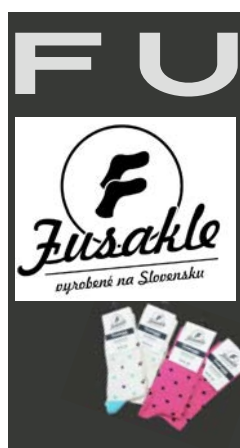

FUSAKLE

100% COOL FAKTOR, 100% FUSAKLE, 100% SLOVAKIA

DESIGN SOCKS MATCHED TO YOUR BIKE
DIZAJNOVÉ PONOŽKY DOLADENÉ K VÁŠMU BIKU



Size / Veľkosť: EU - M(35 - 38) / L (39-42)

??? PINK/RUŽOVÉ



Size / Veľkosť: EU - M(35 - 38) / L (39-42)

??? CREME/KRÉMOVÉ

BELLS / ZVONČEKY

LOOKING FOR A STYLISH AND EFFECTIVE WAY TO COMMUNICATE YOUR PRESENCE ON A BICYCLE TO OTHER ROAD USERS AND PEDESTRIANS?

HLADATE STÝLOVÝ A EFEKTIVNÝ SPOSOB, AKO OZNAMIT SVOJU PRITOMNOSŤ NA BICYKLI INÝM ÚČASŤNÍKOM CESTNEJ PREMÁVKY A CHODCOM?

THE BIG BELL BY BASIL IS A TRENDY BICYCLE BELL FOR YOUR SET. MATCHING BICYCLE BAGS AND BASKETS ALLOW FOR A UNIQUE AND STYLISH TOUR AND CITY LOOK.



BASIL MAGNOLIA

Size / Veľkosť: ø 80 mm

- 50483 BLACKBERRY
- 50482 PASTEL POWDERS



BASIL BOHEME

Size / Veľkosť: ø 80 mm

- 50433 JADE
- 50435 VINTAGE RED



BASIL POLKADOT

Size / Veľkosť: ø 80 mm

- 50397 BLACK-WHITE/ČIERNO-BIELE
- 50399 WHITE-BLACK/BIELO-ČIERNE



BASIL WANDERLUST

Size / Veľkosť: ø 80 mm

- 50439 IVORY
- 50441 ORCHID PINK



BASIL BLOOM

Size / Veľkosť: ø 80 mm

- 50392 GARDENIA WHITE
- 50393 SCARLET RED
- 50395 EMERALD GREEN
- 50424 INDIGO BLUE



VINTAGE SMALL

Size / Veľkosť: ø 60 mm

- 588060270 LIGHTBLUE/SVETLOMODRÝ
- 588060270 PINK/RUŽOVÝ
- 588060270 WHITE/BIELY
- 588060270 RED/ČERVENÝ



VINTAGE PRINT

Size / Veľkosť: ø 80 mm

- 588060280 HEART/SRDCE
- 588060280 BUTTERFLY/MOTÝLE
- 588060280 FLOWERS/KVETY



M-WAVE LADYBIRD

Size / Veľkosť: ø 80 mm

- 420320 RED DOT

VINTAGE BIG

Size / Veľkosť: ø 80 mm

- 588060240 BEIGE/BÉŽOVÝ
- 588060240 PINK/RUŽOVÝ
- 588060240 SILVER/STRIEBORNÝ



DING-DONG MINI

Size / Velkost: ø 33 mm

420181 SILVER ANODISED
STRIEBORNÝ ANODIZOVANY



DURAL BELL

Size / Velkost: ø 53 mm

420118 BLACK/ČIERNY



BELL YWS

Size / Velkost: ø 57 mm

204293 GOLD/ZLATÝ
204292 SILVER/STRIEBORNÝ



BELL STEEL 58

Size / Velkost: ø 57 mm

420011 CHROME/CHROMOV

KIDS BIKE BELLS DETSKÉ ZVONČEKY



LADYBIRD

Size / Velkost: ø 58 mm

588060320 LADYBIRD/LIENKA



CUTE KITTY

Size / Velkost: ø 58 mm

588060320 KITTY/MAČIČKA



PINK OWL

Size / Velkost: ø 58 mm

588060320 OWL/SOVA



GREEN FROG

Size / Velkost: ø 58 mm

588060320 FROG/ŽABA



3D FLOWER

Size / Velkost: ø 55 mm

47PSJ-07 PINK/RUŽOVÝ



LOVE BIKE

Size / Velkost: ø 54 mm

45P-07 WHITE/BIELY
45P-08 BLACK/ČIERNY



FANTASY FLOWER

Size / Velkost: ø 40 mm

588060220 PINK/RUŽOVÝ
588060220 BLUE/MODRÝ
588060220 GREEN/ZELENÝ



FANTASY DOTKA

Size / Velkost: ø 40 mm

588060220 RED/ČERVENÝ



MINI BELL

Size / Velkost: ø 35 mm

L1P1-02 BLUE/MODRÝ
L1P1-08 BLACK/ČIERNY
DK11-04 PINK/RUŽOVÝ

BEEP BEEP!

BIKE HORN IS AN ESSENTIAL ADDITION TO ALL KIDS' BIKES AS IT ENABLES CHILDREN TO ALERT OTHERS TO THEIR PRESENCE WHEN CYCLING ON PUBLIC PATHS. AVAILABLE IN SEVERAL DIFFERENT COLOURS AND DESIGN TO MATCH TO YOUR CHILD'S BICYCLE, IT CAN BE EASILY ATTACHED TO THE HANDLEBARS USING JUST A SCREWDRIVER.

TŮ-TŮ!

CYKLISTICKÝ KLAKSÓN JE ZÁKLADNÝM DOPLNKOM VŠETKÝCH BICYKLOV PRE DETI, PRETOŽE UMOŽŇUJE DEŤOM UPOZORNIŤ OSTATNÝCH NA ICH PRÍTOMNOSŤ PRI JAZDE NA VEREJNÝCH CESTÁCH. K DISPOZÍCII V NIEKOLKÝCH RÔZNYCH FARBÁCH A DIZAJNOCH, ABY ZODPOVEDALI VÁŠMU DETSKÉMU BICYKLU, MÔŽE BYŤ JEDNODUCHO PRIPEVNENÝ NA RIADIDLÁ POMOCOU SKRUTKOVAČA.



HORN UNITO

Size / Veľkosť: ø 58 mm

422001 CHROME-BLACK/CHROM-ČIERNY



HORN TWIST

135005 CHROME-BLACK/CHROM-ČIERNY



HORN DUO

135003 CHROME-BLACK/CHROM-ČIERNY



HORN PLEI COLOR

Size / Veľkosť: ø 73 mm

71YG-10 BLUE/MODRÝ
71YG-06 RED/ČERVENÁ
71YG-01 PINK/RUŽOVÝ



KITTEN

60-56



SPIDER

60-42



DOGGY

422043 DOG/PES



TIGER

601 036



ELEPHANT

200117 ELEPHANT/SLOŇ



CLAWN FISH

422044 FISH/RÝBA



TURTLE

422046 TURTLE/KORYTNAČKA



SHARK

135006 SHARK/ŽRALOK



FROGGY

422048 FROG/ŽABA



DUCK

200101 DUCK/KAČKA



DALMATIN

422042

WATER BOTTLES / FLÁŠE

A BICYCLE BOTTLE IS AN IMPORTANT COMPANION FOR YOUR EVERY RIDE. SUFFICIENT FLUID INTAKE IS ESSENTIAL DURING EACH PHYSICAL ACTIVITY. THE CYCLING BOTTLE IS DESIGNED TO FIT PRECISELY INTO THE BASKET-MOUNTED BASKETS AND CAN EASILY BE DRUNK WHILE DRIVING.

FLÁŠA NA BICYKEL JE DŮLEŽITÝM SPOLOČNÍKOM PRE KAŽDÚ VAŠU VYCHÁDZKU. DOSTATOČNÝ PRÍJEM TEKUTÍN JE NEVYHNUTNÝ POČAS KAŽDEJ FYZICKEJ AKTIVITY. CYKLISTICKÁ FLÁŠA JE NAVRHNUTÁ TAK, ABY PRESNE PASOVALA DO KOŠÍKOV NAMONTOVANÝCH NA RÁME BICYKLA A LAHKO SA Z NEJ DALO PIŤ AJ POČAS JAZDY.



WALIOTH 600cc

WATER BOTTLE 600cc
Original RMK design.
BPE free technology.

WATER BOTTLE 600ML
Originálny RMK dizajn.
Neobsahuje BPE.

401 001 TRANSPARENT/BLACK
401 002 TRANSPARENT/PINK
401 003 BLACK/GREEN



WOLUX 700cc

WATER BOTTLE 700cc
Original RMK design.
BPE free technology.

WATER BOTTLE 700ML
Originálny RMK dizajn.
Neobsahuje BPE.

401 004 TRANSPARENT/BLACK



WOLUX 900cc

WATER BOTTLE 900cc
Original RMK design.
BPE free technology.

WATER BOTTLE 900 ML
Originálny RMK dizajn.
Neobsahuje BPE.

401 005 TRANSPARENT/BLACK

BOTTLE CAGE / KOŠÍKY NA FLÁŠE



WIRIUS

400 701 BLACK/ČIERNY
400 702 WHITE/BIELY



WEGA

400 703 BLACK/ČIERNY



WADI

400 704 BLACK/ČIERNY



WIDO

400 705 BLACK/ČIERNY



WATA

400 709 BLACK/ČIERNY



WONO

400 708 BLACK/ČIERNY



WERIDANUS

400 706 BLACK/ČIERNY
400 707 WHITE/BIELY





GRIPS/RUKOVÄTE

Leather imitation with a perfect vintage look for the most comfortable ride.
Mäkké a veľmi pohodlné rukoväte z kvalitnej imitácie kože s retro vzhľadom.
Ručná výroba z Talianska.

Ergonomic grips made of imitation of leather with luxury design and quilting.
Ergonomicky tvarované rukoväte vyrobené z imitácie kože s luxusným dizajnom a prešíváním.



Retro 014

Size / Veľkosť: 120 mm/90 mm



- 606201-014120 HONEY BROWN/SVETLOHNEDE
- 606201-01490 HONEY BROWN/SVETLOHNEDE
- 606209-014120 DARK BROWN/TMAVOHNEDE
- 606209-01490 DARK BROWN/TMAVOHNEDE
- 606205-014120 BLACK/ČIERNE
- 606205-01490 BLACK/ČIERNE
- 606207-014120 CREAM/KRÉMOVÉ
- 606207-01490 CREAM/KRÉMOVÉ



Size / Veľkosť: 135mm+92mm
PAIR / PÁR



Cruiser

- 606343-310 BLACK-RED/ČIERNO-ČERVENÉ
- 606329-310 BLACK/ČIERNE
- 606339-310 BLACK-GREEN/ČIERNO-ZELENÉ
- 606340-310 WHITE/BIELE
- 606330-310 HONEY BROWN/SVETLOHNEDE

Anatomically shaped for the comfortable touch while cycling. Recommended for city bikes.
Anatomicky tvarované pre pohodlný úchop počas jazdy. Odporúčame pre mestské bicykle.

MINI RETRO



305 008 MINI RETRO



SoftGel

Size / Veľkosť: 125mm
PAIR / PÁR



- 606296-82 BLACK/ČIERNE
- 606360-82 CREAM/KRÉMOVÉ
- 606359-82 TIFFANY
- 606349-82 HONEY BROWN/SVETLOHNEDE



- 606364-82 TIFFANY
- 606299-82 BLACK/ČIERNE
- 606365-82 CREAM/KRÉMOVÉ
- 606366-82 HONEY BROWN/SVETLOHNEDE

SoftGel

Size / Veľkosť:
125mm+92mm
PAIR / PÁR



Silo

Size / Veľkosť: 130 mm
PAIR / PÁR

- 305 002 RED/ČERVENÉ
- 305 001 BLACK/ČIERNE
- 305 003 NEON GREEN/NEON ZELENÉ
- 305 004 NEON YELLOW/NEON ŽLTÉ



velo DISTANCE

- 305 005 GREY/SIVÉ
- 305 006 GREEN/ZELENÉ
- 305 007 PINK/RUŽOVÉ



UniVERSE plus+

Size / Veľkosť: 130 mm
PAIR / PÁR

Made of high quality rubber. Excellent adhesion to the handlebar with aluminum side lock rings.

Vyrobené z kvalitnej gumi. Vynikajúco držia na riadidlách vďaka hliníkovým objímkam, ktoré sa upevňujú skrutkami.

- 606289-201 BLACK-RED/ČIERNO-ČERVENÉ
- 606287-201 BLACK-WHITE/ČIERNO-BIELE
- 606286-201 BLACK-BLACK/ČIERNO-ČIERNE
- 606290-201 BLACK-PINK/ČIERNO-RUŽOVÉ
- 606288-201 BLACK-GREEN/ČIERNO-ZELENÉ



Quality grips with aluminum side lock rings.
Kvalitné rukoväte s hliníkovými objímkami.

Nello

Size / Veľkosť: 130 mm
PAIR / PÁR

- 606342-215 LIGHTBLUE/SVETLOMODRÉ
- 606341-215 BLACK/ČIERNE



ERGOtec E-GRIP

Size / Veľkosť: 135 mm
PAIR / PÁR

- 204065-135MM
- GREY-WHITE/ŠEDO-BIELE



PROLock

Size / Veľkosť: 130 mm
PAIR / PÁR

Grips of high quality made of a combination of rubber and plastic, aluminum side lock rings.

Rukoväte vyrobené z kombinácie kvalitnej gumeny a plastu, hliníkové objímky s Lock-on systémom.



- 606281-312 BLACK-WHITE/ČIERNO-BIELE
- 606284-312 WHITE-BLACK/BIELO-ČIERNE
- 606283-312 BLACK-GREEN/ČIERNO-ZELENÉ



ERGOmyst

Size / Veľkosť: 135 mm
PAIR / PÁR

Ergonomic grips with perfect fit and extra support for your palms.

Ergonomicky tvarované dvojzložkové rukoväte s podporou v oblasti dlani.

- 606295-301 BLACK-BLACK/ČIERNO-ČIERNE
- 606293-301 BLACK-WHITE/ČIERNO-BIELE

Light and comfortable rubber grips. Flesh out the perfect urban look of your bike.

Lahké a komfortné gumenné rukoväte, ktoré perfektne dotvoria mestský vzhľad bicykla.



FIXIE

Size / Veľkosť: 130 mm
PAIR / PÁR

- 606259-VL MAGENTA/RUŽOVÉ
- 606264-VL LIGHT BLUE/SVETLOMODRÉ
- 606265-VL ORANGE/ORANŽOVÉ
- 606268-VL WHITE/BIELE
- 606269-VL VIOLET/FIALOVÉ
- 606266-VL LIGHT GREEN/SVETLOZELENÉ

VULCANO



Size / Veľkosť: 75 mm
PAIR / PÁR



- 606354-1811 BLACK/ČIERNE
- 606305-1811 BLACK-BLUE/ČIERNO-MODRÉ
- 606304-1811 BLACK-RED/ČIERNO-ČERVENÉ
- 606303-1811 BLACK-GREEN/ČIERNO-ZELENÉ
- 606302-1811 BLACK-VIOLET/ČIERNO-FIALOVÉ
- 606301-1811 BLACK-WHITE/ČIERNO-BIELE
- 606348-1811 BLACK-ORANGE/ČIERNO-ORANŽOVÉ

LIME



Size / Veľkosť: 102 mm
PAIR / PÁR



- 300 009 BROWN/HNEDÉ
- 606326-96 WHITE/BIELE
- 606327-96 ORANGE/ORANŽOVÉ
- 606328-96 LIGHT GREEN/SVETLOZELENÉ
- 606324-96 VIOLET/FIALOVÉ
- 606325-96 MAGENTA/RUŽOVÉ
- 606323-96 BLACK/ČIERNE

Straight grips made of quality rubber with plastic body.

Rovné gumenné dvojzložkové rukoväte na plastovom tele.



UniVERSE

Size / Veľkosť: 130 mm
PAIR / PÁR



- 606315-305 BLACK-GREEN/ČIERNO-ZELENÉ
- 606313-305 BLACK-BLACK/ČIERNO-ČIERNE
- 606320-305 BLACK-ORANGE/ČIERNO-ORANŽOVÉ
- 606321-305 BLACK-WHITE/ČIERNO-BIELE
- 606317-305 BLACK-PINK/ČIERNO-RUŽOVÉ
- 606318-305 BLACK-RED/ČIERNO-ČERVENÉ



1400.0

Size / Veľkosť: 115mm
PAIR / PÁR

- 204110-115MM BLACK/ČIERNE

1430.0

Size / Veľkosť: 90mm
PAIR / PÁR

- 204111-1430



1440.0

Size / Veľkosť: 120mm
PAIR / PÁR

- 204205-1440

GRIPS MADE OF HIGH QUALITY RUBBER.

GRIPS ARE SPECIALLY ADAPTED FOR THE BEST TOUCH WHILE RIDING.

RUKOVÄTE COMPACT, VULCANO A YUM SÚ VYROBENÉ Z KVALITNEJ GUMY, KTORÁ JE ŠPECIÁLNE UPRAVENÁ PRE ČO NAJLEPŠÍ ÚCHOP POČAS JAZDY.

COMPACT



Size / Veľkosť: 125 mm
PAIR / PÁR



- 606335-49 BLACK-RED/ČIERNO-ČERVENÉ
- 606334-49 BLACK-WHITE/ČIERNO-BIELE
- 606336-49 BLACK-GREEN/ČIERNO-ZELENÉ
- 606356-49 BLACK-MAGENTA/ČIERNO-RUŽOVÉ
- 606337-49 BLACK-VIOLET/ČIERNO-FIALOVÉ
- 606338-49 BLACK-BLUE/ČIERNO-MODRÉ

YUM



Size / Veľkosť: 90 mm
PAIR / PÁR



- 606311-491 BLACK-BLUE/ČIERNO-MODRÉ
- 606307-491 BLACK-RED/ČIERNO-ČERVENÉ
- 606308-491 BLACK-GREEN/ČIERNO-ZELENÉ
- 606310-491 BLACK-MAGENTA/ČIERNO-RUŽOVÉ
- 606309-491 BLACK-VIOLET/ČIERNO-FIALOVÉ
- 606306-491 BLACK-WHITE/ČIERNO-BIELE
- 606312-491 BLACK-ORANGE/ČIERNO-ORANŽOVÉ



1540

Size / Veľkosť: 90 mm
PAIR / PÁR

- 204204-1540 BLACK/ČIERNE



Are you sitting comfortably?

SADDLES/SEDLA

Sedíte pohodlne?

CHOOSING THE RIGHT BIKE SADDLE CAN HELP YOU GET MORE ENJOYMENT OUT OF EVERY ROAD, TRAIL, AND CITY RIDE.

VYBER SPRAVNEHO SEDLA NA BICYKLI VAM POMOŽE ZISKAT VIAC POŽITKU Z KAZDEJ CESTY, TRAILU A JAZDY PO MESTE.



MALENA

- 223262-1750MA HONEY BROWN/SVETLOHNEDE
- 223260-1750CC CREAM/KREMOVÉ
- 223261-1750NE BLACK/ČIERNE



CRUISER

- 223121-1561240516 BLACK/ČIERNE SO ZELENOU NIŤOU
- 223125-1561260520 WHITE/BIELE S BÉŽOVOU NIŤOU
- 223126-1561260521 HONEY BROWN/SVETLOHNEDE
- 223111-1561260502 BLACK/ČIERNE S ČIERNOU NIŤOU
- 223130-1561260526 ORANGE LIME
- 223123-1561260518 BLACK/ČIERNE S MODROU NIŤOU
- 223120-1561240009 BLACK/ČIERNE S MODROU PRUŽINOU
- 223129-1561260601 MUSTACHE
- 223119-1561260601 POLKA DOT/BODKOVANÉ



DE LUXE

- 504016-CR3010EL CREAM/KREMOVÉ
- 504001-3010EL BLACK/ČIERNE
- 504003-XC3010EL HONEY BROWN/SVETLOHNEDE
- 504004-TM3010EL DARK BROWN/TMAVOHNEDE



CRUISER 1100

- 604280-SMG1100
- BLACK/ČIERNE



FELIZ

- 604426-NTI1610 TIFANY
- 604423-NXC1610 HONEY BROWN/SVETLOHNEDE
- 604422-NCR1610 CREAM/BÉŽOVÉ
- 604437-NFA1610 PIETRA NEUTRO
- 604424-NTM1610 BLACK/ČIERNE
- 604438-NVI1610 VIOLET/FIALOVÉ
- 604431-NBL1610 ATLANTIS BLUE/MODRÉ
- 604430-PP1610 PIQUET



WAVE GEL 8204HGE

- 223059-SR903 BLACK/ČIERNE



WAVE 8204HC

- 223254-SR16 BLACK/ČIERNE



URBAN FIXIE

- 604265-NSK031 BLACK/ČIERNE
- 604267-NSK031 BLUE/MODRÉ
- 604266-NSK031 WHITE/BIELE



URBAN FIXIE

- 604233-VL1356 WHITE/BIELE



The Fizik Ardea Manganese Saddle has a versatile Chameleon profile combined with Fizik's quality comfort and style in affordable package. Features include Nylon Carbon Reinforced base, Integrated Clip System and Manganese rails.

FÍZIK ARDEA

- 604220 BLACK/ČIERNE
- 604214 RED/ČERVENÉ
- 604218 YELLOW/ŽLTÉ
- 604207 WHITE/BIELE
- 604213 NEON YELLOW/NEON ŽLTÉ

Size / Veľkosť: 273x142 mm
Weight / Hmotnosť: 264 g

When touring, you're likely to adopt a more upright position, not dissimilar to a mountain bike position. You need a saddle that's comfortable for sitting without moving for long hours.

Pri dlhých jazdách budete pravdepodobne jazdiť vo viac vzpriamenej pozícii, odlišnej od pozície na horskom bicykli. Potrebujete sedlo, ktoré je pohodlné na sedenie bez dlhého pohybu.



DISTANCE

- 604 461 NEON GREEN/NEON ZELENÉ
- 604 449 GREEN/ZELENÉ
- 604 460 BLACK/ČIERNE
- 604 462 TYRKYS
- 604 463 PINK/RUŽOVÉ



SR SIRIO

- 604235-17302 BLACK/ČIERNE
- 604234-87622 RED/ČERVENÉ
- 604236-87644 BLUE/MODRÉ
- 604237-87633 NEON YELLOW/NEON ŽLTÉ



Q (KJU):

- 604439-2062 BLACK/ČIERNE
- 604350-2062 WHITE-BLUE/BIELO-MODRÉ
- 604349-2062 GREY-RED/SIVO-ČERVENÉ
- 604348-2062 GREY-ORANGE/SIVO-ORANŽOVÉ
- 604352-2062 VIOLET-MENTHOL/FIALOVO-MENTOLOVÉ
- 604351-2062 ORANGE-PINK/ORANŽOVO-RUŽOVÉ



SHADE

- 604345-3050D GREEN/ZELENÉ
- 604346-3050D BLACK/ČIERNE
- 604342-3050D RED/ČERVENÉ
- 604440-3050D GREY/SIVÉ
- 604343-3050D MENTHOL/MENTOLOVÉ
- 604341-3050D ORANGE/ORANŽOVÉ
- 604340-3050D PINK/RUŽOVÉ



STROLLER K280

- 604386-K280RO RED/ČERVENÉ
- 604398-K280AR ORANGE/ORANŽOVÉ
- 604391-K280VE GREEN/ZELENÉ
- 604455-K280AZ TYRKYS
- 604397-K280VI VIOLET/FIALOVÉ
- 604387-K280BI WHITE/BIELE
- 604390-K280BL BLUE/MODRÉ
- 604457-K281 BLACK/ČIERNE



SMG 025

223003-SMG025

BRAVO 115

223016-SMG115

CTB 063B

223241-SMG063B

CTB 012

223001-SMG012



CTB 07

223013-SMG07

CTB 016

223224-SMG016

CTB 04

223005-SMG004

CTB 360

223244-SMG360



K2 GEL

223235-SMGK2

K2

223011-K2

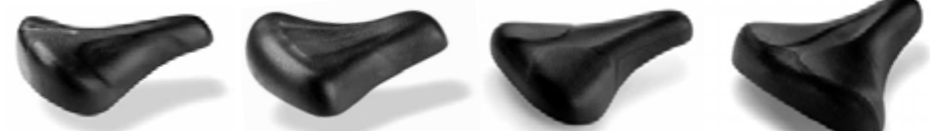

CTB 105

223018-SMG105

CTB 150

223248-SMG150

CTB 910

223242-SMG910

CTB 156

223245-SMG156



JUNIOR VINTAGE



306 025-998000
BROWN/HNEDÉ



CRUISER 1561
223133-1561 WHITE/BIELE

KIDS²⁴



604375-998000 BLUE/MODRÉ
604374-998000 GREEN/ZELENÉ
306 030-998000 NEONGREEN/NEONZELENÉ
604433-998000 GREY/SIVÉ
604420-998000 RED/ČERVENÉ
604415-998000 PINK/RUŽOVÉ
604416-998000 VIOLET/FIALOVÉ

VULCANO²⁴



604403-998000 GREEN-BLUE/ZELENO-MODRÉ
604402-998000 RED-BLUE/ČERVENO-MODRÉ
604405-998000 VIOLET-TYRKYS/FIALOVO-TYRKYSOVÉ
604404-998000 LOSOS-PETROLEUM/LOSOSOVO-PETROLEJOVÉ

KIDS²⁰



604414-998000 RED/ČERVENÉ
604381-996000 BLUE/MODRÉ
604380-998000 GREEN/ZELENÉ
306 029-998000 WHITE/BIELE
604212-998000 VIOLET/FIALOVÉ
640371-998000 PINK/RUŽOVÉ



KALEO²⁰
604395-996000 GREEN/ZELENÉ

KALEA²⁰



604395-996000 VIOLET/FIALOVÉ
604413-996000 RED/ČERVENÉ



K 121-20

223086-SV121 GREEN/ZELENÉ
223087-SV121 ORANGE/ORANŽOVÉ



VINTAGE²⁰



306 026-998000
BROWN/HNEDÉ

VINTAGE¹⁶



306 027-998000
BROWN/HNEDÉ



MIA¹⁶

604409-995000
LIGHTBLUE/SVETLOMODRÉ

KIDS¹⁶



604353-995000 GREEN/ZELENÉ
604435-995000 BLUE/MODRÉ
306 028-998000 WHITE/BIELE
604372-995000 VIOLET/FIALOVÉ
604436-995000 PINK/RUŽOVÉ



LIME¹⁶

604396-995000 GREEN/ZELENÉ



D160C

300 029-D160C RED/ČERVENÉ



075 PONY PU¹²⁻¹⁴
306 031 BLACK/ČIERNE



135 PU¹⁶⁻²⁰
306 032 BLACK/ČIERNE



VENTURA¹⁶
604222-16000 BLACK/ČIERNE



MINI
223070-Z7002 BLACK/ČIERNE

MIX & MATCH



KICKSTANDS/BOČNÉ STOJANY

URSUS 



20
24"
26"
28"

URSUS ELEGANCE ADJ BLACK

606 175-76NV000
BLACK/ČIERNY

- Aluminium/hliník
- 20" - 24"
- Adjustable/ Nastaviteľný

URSUS 



20
24"
26"
28"

URSUS ELEGANCE ADJ SILVER

606 176-76CV000
SILVER/STRIEBORNÝ

- Aluminium/hliníkový
- 20" - 24"
- Adjustable/ Nastaviteľný

URSUS 



26"
28"

URSUS EASY 92

606 181- 92VN005 BLACK/ČIERNY

- Aluminium
- Perfect stability
- No tools adjustable
- Maximum load capacity: 25 kg
- 26" - 28"
- Adjustable
- Hliníkový
- Dokonalá stabilita
- nastavenie dĺžky bez náradia
- Maximálna nosnosť: 25 kg
- 26 " - 28"
- Nastaviteľné

URSUS 



26"
28"

URSUS MOOI

606 179-90VN005
BLACK/ČIERNY

- Aluminium
- Perfect stability
- No tools adjustable
- Maximum load capacity: 25 kg
- 26" - 28"
- Adjustable

606 180- 90VS005
SILVER/STRIEBORNÝ

- Hliníkový
- Dokonalá stabilita
- Žiadne nástroje na nastavenie dĺžky
- Maximálna nosnosť: 25 kg
- 26 " - 28"
- Nastaviteľné

URSUS 



26"
28"

URSUS MOOI R90

232 046- 90VN01R BLACK/ČIERNY

- Aluminium
- Rear kickstand
- Perfect stability
- fixing plate 18mm and 40 mm
- Maximum load capacity: 25 kg
- 26" - 28"
- Adjustable
- Hliníkový
- Zadný stojan
- Dokonalá stabilita
- upevnenie: 18mm a 40 mm
- Maximálna nosnosť: 25 kg
- 26 " - 28"
- Nastaviteľné

URSUS 



26"
28"



URSUS KAISER 69

606 182- 69VN005 BLACK/ČIERNY

- Alloy
- Great Stability
- Wide angle when the kickstand is open
- 26" 28"
- Length-adjustable innovative system with 2 fixing screws
- Maximum load capacity: 55 kg
- Hliníkový
- Veľká stabilita
- Široký uhol, keď je stojan otvorený
- 26 "28"
- Inovatívny systém s nastaviteľnou dĺžkou s 2 skrutkami
- Maximálna nosnosť: 55 kg



26"
28"

PLETSCHER 52516

606172-52516 BLACK/ČIERNY

- Aluminium
- Length-adjustable in 7.5 mm steps
- max. Strut length 325mm
- Wide plastic foot
- Weight 240g
- max. Load 18kg
- Hliníkový
- Dĺžka nastaviteľná v krokoch po 7,5 mm
- max. Dĺžka vzpery 325 mm
- Široká plastová päťka
- Hmotnosť 240 g
- max. zataženie 18 kg



24"
28"

spanninga

SPANNINGA EXTEND

606 173-3680000 BLACK/ČIERNY

- Central mount 30mm plate
- 24" to 28"
- Aluminium & plastic
- Weight capacity: 35kg
- Stredový držiak 30mm
- 24 "až 28"
- Hliník a plast
- Nosnosť: 35 kg



26"
28"



URSUS HOPPER 69

606 171- 83VN205 BLACK/ČIERNY

- 40 cm wide when legs are expanded
- 20 cm wide when legs are folded
- Capacity load 50 kg
- 26" 28"
- 40 cm, keď sú nohy vysunuté
- 20 cm, keď sú nohy zložené
- Nosnosť 50 kg
- 26 "28"



26"
28"

RMK

M430

232 058-430772
BLACK/ČIERNY

Steel/ocel
26" - 28"
behind bottom bracket



16"
20"

RMK

RMK QK01

232 040- QKCA01A
BLACK/ČIERNY

- Aluminium/hliníkový
- 16" - 20"
- Adjustable/ Nastaviteľný



16"
20"

RMK

RS20

232 001- TBD-RS20 BLACK/ČIERNY

Kickstand BB bridge mounting Aluminium adjustable 16"-20"

Stojan na stred, hliníkový, nastaviteľný 16"-20"

CARRIERS - NOSIČE

REAR/ZADNÉ



DURAL REAR
223023-262800 SILVER/STRIEBORNÝ
 Wheel Size / Veľkosť kolies: 26" - 28"



CARRIER REAR
405 002 BLACK/ČIERNY
 Adjustable / Nastaviteľný
 Wheel Size / Veľkosť kolies: 24" - 28"

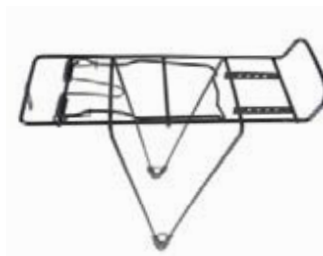

CARRIER REAR
225044-280000 BLACK/ČIERNY
 Wheel Size / Veľkosť kolies: 28"

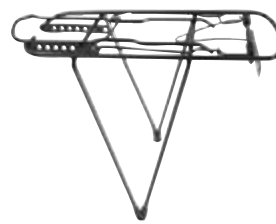

CARRIER REAR
225024-260000 BLACK/ČIERNY
 Adjustable / Nastaviteľný
 Wheel Size / Veľkosť kolies: 26"



CARRIER REAR
225020-260000 BLACK/ČIERNY
 Wheel Size / Veľkosť kolies: 26"

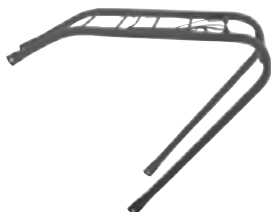

CRUISER REAR
225054-260000
 color of choice /farba podľa výberu
 Wheel Size / Veľkosť kolies: 26"



CARRIER REAR
405 001 BLACK/ČIERNY
 Wheel Size / Veľkosť kolies: 20"



CARRIER REAR KIDS
225041-160000 BLACK/ČIERNY
 Wheel Size / Veľkosť kolies: 20"



CARRIER REAR
405 005 BLACK/ČIERNY
 Wheel Size / Veľkosť kolies: 26" - 28"



CARRIER REAR
405 004 BLACK/ČIERNY
 Wheel Size / Veľkosť kolies: 26" - 28"

CARRIER REAR NOSTALGIC

405 006-604084 26"
405 007-225027 28"
 color of choice /farba podľa výberu
 Wheel Size / Veľkosť kolies: 26"/28"



CARRIER FRONT
225124-34506G00 BLACK/ČIERNY
 upevnenie na pivoť



CARRIER FRONT 16MM
405 003 16MM
 Wheel Size / Veľkosť kolies: 26"-28"



CARRIER FRONT
225053-260000 BLACK/ČIERNY



CARRIER FRONT
225123-314F0G00
 SILVER/STRIEBORNÝ

FRONT/PREDNÉ

MUDGARDS/BLATNÍKY



16" RMK KIDO CHOPPER SDL

- 403 009 black/čierny
- 403 010 black-neon green/ čierno-neon zelený
- 403 011 black-lime/ čierno-limetkový



20" RMK KIDO CHOPPER SDL

- 403 015 black/čierny
- 403 016 black-neon green/ čierno-neon zelený
- 403 017 black-lime/ čierno-limetkový



20/24" RMK KIDO CHOPPER SDE

- 403 024 black/čierny
- 403 025 black-neon green/ čierno-neon zelený
- 403 026 black-lime/ čierno-limetkový



16" RMK KIDO CHOPPER SDL

- 403 012 white/biely
- 403 013 white-red/bielo-červený
- 403 014 white-menthol/ bielo-tyrkysový
- 403 023 white-pink/ bielo-ružový



20" RMK KIDO CHOPPER

- 403 018 white/biely
- 403 019 white-red/bielo-červený
- 403 020 white-menthol/ bielo-tyrkysový
- 403 021 white-neon green/bielo-neon zelený
- 403 022 white-pink/ bielo-ružový



20/24" RMK KIDO CHOPPER SDE

- 403 027 white/biely
- 403 028 white-pink/ bielo-ružový
- 403 029 white-menthol/ bielo-tyrkysový
- 403 046 white-red/bielo-červený
- 403 047 white-neon green/bielo-neon zelený



26"/28" MRCN CHROMOPLAST I

- 403 041 26" black/čierny
- 403 042 28" black/čierny

single stays / jedno vzepa



28" MRCN CHROMOPLAST II

- 403 043 28" black gloss/čierny lesklý
- 403 044 28" black matte/čierny matný

doble stays / dvojitá vzepa

20"/24"/28" RPZ CHROMOPLAST

- 403 034 20" silver/ strieborný
- 403 035 20" black/čierny
- 403 036 24" silver/ strieborný
- 403 037 26" silver/ strieborný
- 403 038 24" silver/ strieborný
- 403 039 28" black/čierny
- 403 040 28" silver/ strieborný

12"/16" ROTO ZIGY

- 403 030 12" white/biely
- 403 031 12" black/čierny
- 403 032 16" white/biely
- 403 033 16" black/čierny

26" NICE FAREBNÝ/COLOR 403 045

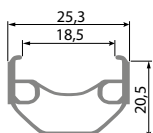

RMK Zion Disc

Size Veľkosť:	ETRTO:	NUMBER OF HOLES Počet dier:	WEIGHT Hmotnosť:
20"	406-19C	36	403g
24"	507-19C	36	487g
26"	559-19C	36	532g
27,5"	584-19C	32/36	559g
28"	622-19C	32/36	595g

APPLICATION/POUŽITIE: Disc clincher
 TYRE TYPE/TYP PNEUMATIKY: disc
 BRAKE TYPE/TYP BRZDY: none
 TUBELESS SYSTEM: aluminium (6106)
 MATERIAL: 100kg
 MAX SYSTEM WEIGHT/MAX. NOSNOSŤ:

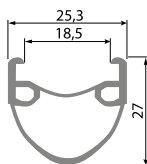

RMK SoA

Size Veľkosť:	ETRTO:	NUMBER OF HOLES Počet dier:	WEIGHT Hmotnosť:
20"	406-19C	36	443g
24"	507-19C	36	559g
26"	559-19C	36	610g
26" x 1 3/8"	590-19C	36	650g
27,5"	584-19C	36	640g
28"	622-19C	36	684g

APPLICATION/POUŽITIE: Optional Disc or V-brake clincher
 TYRE TYPE/TYP PNEUMATIKY: rim
 BRAKE TYPE/TYP BRZDY: none
 TUBELESS SYSTEM: aluminium (6106)
 MATERIAL: 100kg
 MAX SYSTEM WEIGHT/MAX. NOSNOSŤ:

Size Veľkosť:	ETRTO:	NUMBER OF HOLES Počet dier:	WEIGHT Hmotnosť:
28x1 3/8"	635-20C	36	454g
27x1 1/4"	630-20C	36	450g
26x1 3/8"	590-20C	36	424g
26"	559-20C	36	403g
24x1 3/8"	540-20C	36	386g
24"	507-20C	36	365g
20"	406-20C	28/36	297g
18x1.75"	355-20C	20	255g
16"	305-20C	20	224g
12"	203-20C	16/20	182g

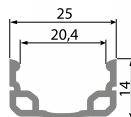

RMK ReA

APPLICATION/POUŽITIE: V-brake clincher
 TYRE TYPE/TYP PNEUMATIKY: rim
 BRAKE TYPE/TYP BRZDY: none
 TUBELESS SYSTEM: aluminium (6106)
 MATERIAL: 100kg
 MAX SYSTEM WEIGHT/MAX. NOSNOSŤ:



MTB LINE

If you're looking for a high volume tire with low rolling resistance then look no further than the CST Fringe. The Fringe has a grouping of tightly spaced ramped knobs that for low rolling resistance with a side and mid knob that will inspire cornering.

Ak hľadáte plášť s veľkým objemom s nízkym valivým odporom, potom nehľadajte viac ako CST Fringe. Fringe má zoskupenie pevne rozmiestnených otočných gombíkov.

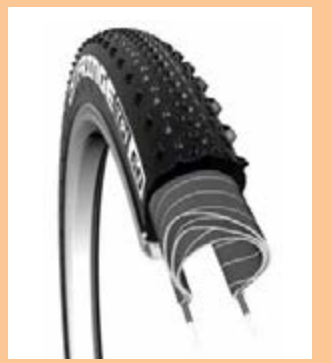

FRINGE C-1918

300 027	27,5x2,10 C
300 026	29x2,10 C
300 028	26x1,95 C (53-559)



GRIZZLY PEAK C-1391

300 017	26x1,95 (50-559)
300 015	24x1,95 (53-507)



MAROON PEAK C-1417N

300 019	26x2,10 (54-559)
----------------	------------------



CONTROL TERRA C-1313

300 023	26x1,75 (47-559)
300 022	26x1,50 (40-559)



CABALLERO C-1563

300 029	29x2,10
300 030	27,5x2,10
300 031	26x2,0 (52-559)
300 032	26x1,90



SPEED SEVEN C-1820

300 033	29x2,10
300 034	27,5x2,10
300 035	26x1,95 (50-559)



CONTROL PLUS C-1436

300 036	700x42C (40-622)
300 037	26x1,95 C (53-559)

CITY TREKKING LINE



X-PEDIUM C-1880

We meticulously developed a quiver of puncture protection technologies, compound types and sizes to meet rider's needs to a T. This tire is built to get riders through town without punctures and also gives them reliable traction, all without overloading their budget.

Precízne sme vyvinuli technológie na ochranu proti prepichnutiu, typy zmesi a veľkosti, aby sme splnili potreby jazdcov. Tento plášť je postavený tak, aby jazdci prechádzali mestom bez defektov a zároveň im dávali spoľahlivú trakciu, to všetko bez preťaženia rozpočtu.

300 039	700X38C (40-622)
300 040	28x1 1/2 (40-622)
300 038	26x1,75 (47-559)



The Sensamo Allround features a grooved-slick tread design and moderate extended side tread for increased sidewall protection. The Sensamo Allround also offers a APL reinforcement for improved puncture protection and a reflective sidewall for improved night visibility.

Sensamo Allround je vybavený drážkovaným hladkým dezénom a miernym predĺženým bočným behúňom na zvýšenie ochrany bočnej steny. Sensamo Allround ponúka tiež zosilňovač APL pre lepšiu ochranu proti prepichnutiu a reflexnú bočnú stenu pre lepšiu viditeľnosť v noci.

SENSAMO ALLROUND C-1698

300 043	700X38C (40-622)
300 042	28x1 1/2 (40-622)
300 041	28x1 5/8x1 1/4 (37-622)

APL
APL features a respectable 0.7mm layer of rubber between the tread and the casing. This additional rubber layer assists in preventing penetration through the tire.

APL
APL má slušnú 0,7mm vrstvu gumy medzi behúňom a puzdrom. Táto prídavná gumová vrstva pomáha zabrániť prieniku cez plášť.



C-1241

300 044	26x1 3/8 (37-559)
----------------	-------------------



URBAN TYRE C-245

300 045	26x1 1/2 (40-559)
----------------	-------------------



CB321

300 008	26x1 1/2x2 (40-559)
----------------	---------------------



CONTROL CRUISER C-241

300 046	26x2,125 (57-559)
----------------	-------------------

BLACK-WHITE/ČIERNO-BIELE



ACIMUT SOKOTO S-116

- 300 047 700x38C (40-622) BROWN/HNEDÉ
- 300 049 700x38C (40-622) APPLE GREEN/TYRKYSOVÉ
- 300 048 700x38C (40-622) CREAM/KRÉMOVÉ
- 300 050 24x1,75 BROWN/HNEDÉ
- 300 051 24x1,75 CREAM/KRÉMOVÉ
- 300 052 700x38C (40-622) BLACK/ČIERNE



SELECTA C-1490

- 300 053 700x38C (40-622) VIOLET/FIALOVÉ
- 300 054 700x38C BLACK/ČIERNE
- 300 055 26x1,75 (47-559) APPLE GREEN/TYRKYSOVÉ
- 300 056 26x1,75 (47-559) BROWN/HNEDÉ
- 300 057 26x1,75 (47-559) VIOLET/FIALOVÉ
- 300 058 26x1,75 (47-559) BLACK/ČIERNE



LUGO C-1118

- 300 059 700x38C(40-622) BROWN/HNEDÉ
- 300 060 24x1 3/8 (37-540) BLACK/ČIERNE



CONTROL VIVA C-1446

- 300 061 700x40C BLACK-VIOLET SIDEWALL/ČIERNE S FIALOVÝM BOKOM
- 300 062 700x38C (40-622) CREAM/KRÉMOVÉ
- 300 063 700x38C (40-622) BROWN/HNEDÉ
- 300 084 26x1,75 (47-559) CREAM/KRÉMOVÉ
- 300 064 26x1,75 BLACK-CREAM SIDEWALL/ČIERNE S KRÉMOVÝM BOKOM
- 300 065 24x1,75 (47-507) BLACK/ČIERNE
- 300 066 20x1,75 BROWN/HNEDÉ
- 300 067 20x1,75 CREAM/KRÉMOVÉ
- 300 068 20x1,75 (47-406) BLACK/ČIERNE
- 300 069 16x1,75 BROWN/HNEDÉ
- 300 070 16x1,75 (47-305) BLACK/ČIERNE



SORIA C-1103

- 300 071 700x35C (37-622)



NEW ALMELO C-979

- 300 072 700x35C (37-622)



C-1345

- 300 073 24x1,95
- 300 074 20x1,95 (53-406)



CLASSIC ALICE C-727

- 300 083 20x1,75 (47-406)
- 300 075 26x2,125



CLASSIC ZERO C-213

- 300 076 20x1,75 (47-406)
- 300 077 20x1,95 (47-406) BROWN/HNEDÉ
- 300 078 20x1,95 BLACK/ČIERNE
- 300 079 16x1,95 BLACK/ČIERNE



C-1213N

- 300 080 16x1,95 (53-305)



LARK C-712

- 300 081 12x1/2x2 1/4 (57-203)



CUCKOO C-1456

- 300 082 12x1/2x2 1/4 (57-203)





INTELLIGENT BIKE SHARING SYSTEM

INTELENTNÝ SYSTÉM ZDIEĽANÝCH ELEKTRICKÝCH BICYKLOV

- ▶ STATIONS FOR 2 TO 64 BIKES (E-BIKES, BICYCLES, E-SCOOTERS, E-CARGO BIKES)
- ▶ 100% AUTOMATIC CHARGING SYSTEM
- ▶ EASY TO USE SYSTEM
- ▶ CENTRALIZED MANAGEMENT
- ▶ GPS BIKE TRACKING AND LOCATION OF STATIONS
- ▶ ACCESS VIA RFID CARDS (URBAN, BUSINESS CARDS) OR SMARTPHONES
- ▶ SMART PAYMENT SOLUTIONS
- ▶ PERSONALIZED WEB PLATFORM / APPLICATION
- ▶ POSSIBILITY OF HEATING THE BATTERIES
- ▶ STATIONS WITH PHOTOVOLTAIC PANELS
- ▶ STANICE PRE 2 AŽ 64 BICYKLOV (E-BICYKLE, BICYKLE, E-KOLOBEŽKY, E-CARGO BICYKLE)
- ▶ 100% AUTOMATICKÝ SYSTÉM DOBÍJANIA
- ▶ ĽAHKO OVLÁDATEĽNÝ SYSTÉM
- ▶ CENTRALIZOVANÉ RIADENIE
- ▶ GPS SLEDOVANIE BICYKLOV A LOKÁCIA STANÍC
- ▶ PRÍSTUP CEZ RFID KARTY (MESTSKÉ, PODNIKOVÉ KARTY) ALEBO SMARTFÓNY
- ▶ SMART PLATOBNÉ RIEŠENIA
- ▶ PERSONALIZOVANÁ WEBOVÁ PLATFORMA / APLIKÁCIA
- ▶ MOŽNOSŤ VYHRIEVANIA BATÉRIÍ
- ▶ STANICE AJ S FOTOVOLTICKÝMI PANELMI

ELEGANT, SOLID, EFFICIENT AND RELIABLE

ELEGANTNÉ, PEVNÉ, EFEKTÍVNE A SPOĽAHLIVÉ

PERSONALIZED BICYCLES AND TAILOR-MADE SOLUTIONS

PERSONALIZOVANÉ BICYKLE DO KAŽDÉHO TERÉNU A RIEŠENIA ŠITÉ NA MIERU

E-TOWN

A new alternative public transport system for cities and municipalities, adapting to the existing framework and infrastructure. The community will consider the number of stations, some with payment terminals, with lots of bicycles in circulation. Access to bicycles will be possible by means of a prepaid card or by credit card or smartphone. A sophisticated management system will be created to facilitate network maintenance and offer a mobile application to facilitate user access.



E-MESTO

Nový alternatívny systém verejnej dopravy pre mestá aj obce, ktorý sa prispôsobí existujúcemu rámcu a infraštruktúre. Komunita si zväží počet staníc, niektoré s platobnými terminálmi, s množstvom bicyklov v obehu. Prístup k bicyklom bude umožnený pomocou predplatennej karty alebo platbou prostredníctvom kreditnej karty prípadne cez smartfón. Vytvorí sa prepracovaný systém riadenia, ktorý uľahčí údržbu siete a ponúkne mobilnú aplikáciu na uľahčenie prístupu k užívateľom.

E-BUSINESS

Environmentally friendly, fast, cheap and easy to use transport for your business and employees. A small and medium-sized enterprise whose employee travels frequently selects a basic version with 5 or 6 charging stations and access via RFID key cards. E-bikes can therefore be used permanently. A company with hundreds of employees with buildings in multiple locations will opt for a more complete system with stations located at each location, branded bicycles in company colour and a connection to the company's access system. Employees can check the availability of bikes via the Internet, book them and move quickly from one location to another.



E-PODNIK

Ekologický, rýchly, lacný a ľahko použiteľný dopravný prostriedok pre Váš podnik a zamestnancov. Malý a stredný podnik, ktorého zamestnanec cestuje často, si vyberie základnú verziu s 5 alebo 6 nabíjacími stanicami a prístup pomocou RFID kľúčových kariet. Elektronické bicykle sa preto môžu používať natrvalo. Spoločnosť so stovkami zamestnancov s budovami na viacerých miestach sa rozhodne pre kompletnejší systém so stanicami umiestnenými na každej lokalite, bicykle vo farbách spoločnosti a pripojenie k prístupovému systému spoločnosti. Zamestnanci môžu skontrolovať dostupnosť bicyklov cez internet, rezervovať ich a rýchlo sa pohybovať z jedného miesta do druhého.

E-TOURISM

Suitable for hotels or tourist resorts. Several bikes at the station, several access cards at the reception, and a quick billing system after each use allow easy management and added attraction for your customers.



E-TURIZMUS

Vhodné riešenie pre hotely alebo turistické strediská. Niekoľko bicyklov na stanici, niekoľko prístupových kariet na recepcii a rýchly fakturačný systém po každom použití umožnia ľahké riadenie a pridanú atrakciu pre Vašich zákazníkov.

E-UNIVERSITY

University bike rental, or inter-faculty transport.



E-UNIVERZITA

Univerzitný prenájom bicyklov, či medzifakultná doprava.

SWISS SYSTEM AND SLOVAK BICYCLES. EFFECTIVE AND ENVIRONMENTAL TRANSPORT

ŠVAJČIARSKY SYSTÉM A SLOVENSKÉ BICYKLE. EFEKTÍVNA A EKOLOGICKÁ DOPRAVA

REFERENCES / REFERENCIE



FRANCE / FRANCÚZSKO



OS DRAVA, PUBLIC BIKE SYSTEM
HUNGARY/MADARSKO



TELENOR
NORWAY / NÓRSKO



RÉUNION



OBOS KVAERNERBYEN
NÓRSKO, OSLO



WTO GENEVA,
SUISSE / ŠVAJČIARSKO



PARKING INDIGO, GREEN-ON PARIS &
MARSEILLE, FRANCE / FRANCÚZSKO



FOR LITTLE
PEOPLE
WITH BIG
HEART

PRE L'UDÍ
NÍZKEHO VZRASTU
S VEĽKÝM
SRDCOM



COLORS OF 2020

	X01 BLACK / ČIERNA		X19 ROYAL BLUE / KRÁĽOVSKÁ MODRÁ		X46 PROCESS BLUE
	X02 WHITE / BIELA		X20 METTALIC BLUE / PERLEŤ MODRÁ		X47 NEON GREEN / NEON ZELENÁ
	X03 BEIGE / BÉŽOVÁ		X25 LEMON FLUO		X40 TRAFFIC RED / DOPRAVNÁ ČERVENÁ
	X04 TELLURIUM		X26 LIME / LIMETKA		X52 NEW BUBBLE GUM
	X06 GHARDAIA		X27 NEON YELLOW		X53 HELLROSA / STARO RUŽOVÁ
	X07 CHROMO / CHRÓM		X31 NEON MANGO		X54 TRAFFIC BLUE 5017
	X09 METALLIC / METALÍZA		X32 FERRARI		X55 FLUO PINK / FLUO RUŽOVÁ
	X10 SMOKE / DYMOVÁ		X33 BORDO		X56 FLUO GREEN / FLUO ZELENÁ
	X11 BROWN / HNEDÁ		X34 LILLA		X57 FLUO ORANGE / FLUO ORANŽOVÁ
	X12 MILITARY		X35 PINK-PINK		X58 ROSE QUARTZ / PASTEL RUŽOVÁ
	X13 PISTACCHI / PISTÁCIOVÁ		X36 SALMON / LOSOS		X60 STEEL BLUE/ OCEĽOVO MODRÁ
	X14 TYRKYS		X39 MILKA		
	X15 PETROLEUM		X40 VIOLET/FIALOVÁ		
	X18 SKY BLUE / NEBOVOMODRÁ		X45 NEW KAWASAKI		

FINISH / POVRCH

(5XX)	Shiny / Lesklý lak
(6XX)	Matte / Matný lak
(7XX)	Semi matte / Polomatný lak
(9XX)	Pearl / Perleťový lak

BICYCLE COLOR CODE GUIDE / PRÍRUČKA K POUŽÍVANIU KÓDOV BICYKLOV

Each bicycle in the catalogue has a specific code from which the individual colors are readable and they can be compared to the color chart.
V katalógu nájdete ku každému bicyklu priradený osobitý kód, z ktorého sú čitateľné jednotlivé farby a teda je možné ich porovnať so vzorkovníkom farieb.

HOW TO UNDERSTAND MODEL CODE / AKO ČÍTAŤ A ORIENTOVAŤ SA V KÓDE

THE CODE CONSISTS OF / KÓD POZOSTÁVA

A B C - D E F G

A

Powder coating finish / Povrchová úprava

- 5) shiny finish / lesklý povrch
- 6) matt finish / matný povrch
- 7) semi matt finish / polomatný povrch
- 9) pearl finish / perleťový povrch

BC

Frame colour code referring to the KENZEL colour swatch
Farba rámu podľa KENZEL vzorkovníka farieb

KENZEL Colour Swatch is available for reference at your local dealer
Kenzel vzorkovník farieb dostupný k nahliadnutiu u Vášho predajcu

DEFG

Internal code of decals / Interný kód nálepiek

EXAMPLE / PRÍKLAD
NOSTALGIC DELUXE 3SPD

503-1391
5 - shiny finish / lesklý povrch 03 - beige / béžová 1391 - interný kód nálepiek/sticker code

NOSTALGIC DELUXE

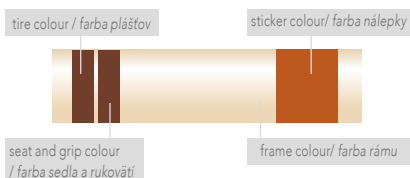

WIND

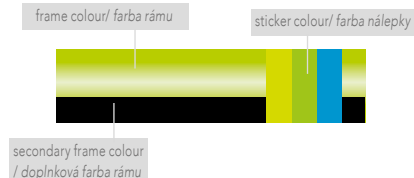

CRUISER

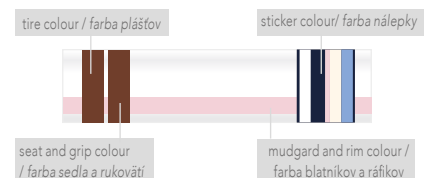

SIZE CHART / VEĽKOSTNÁ TABUĽKA

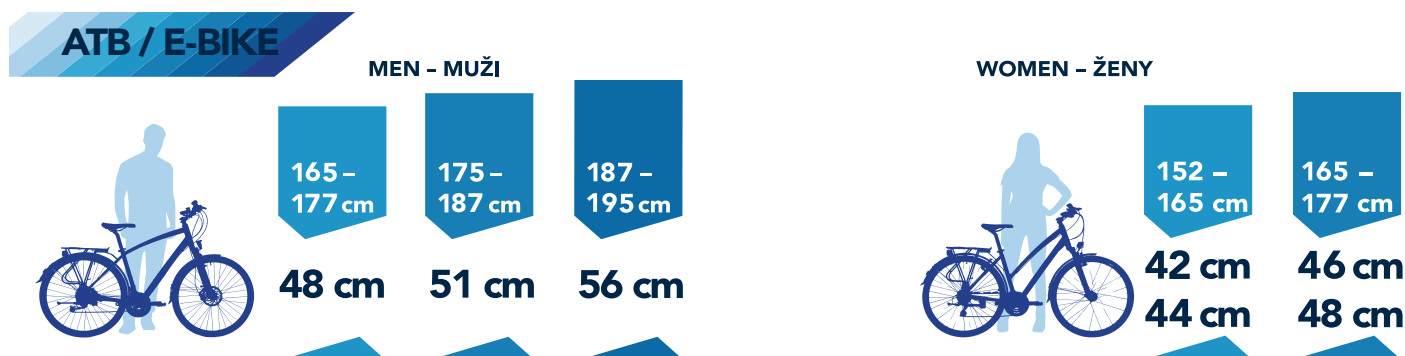
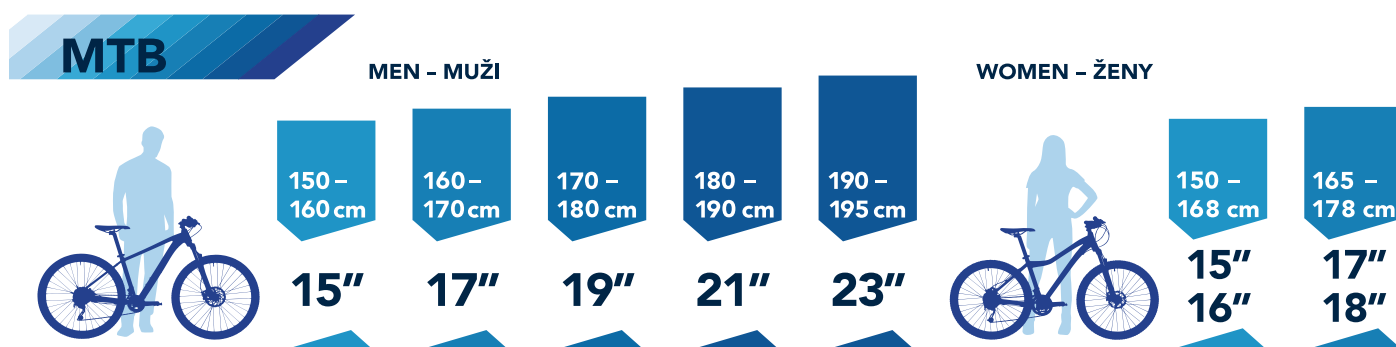
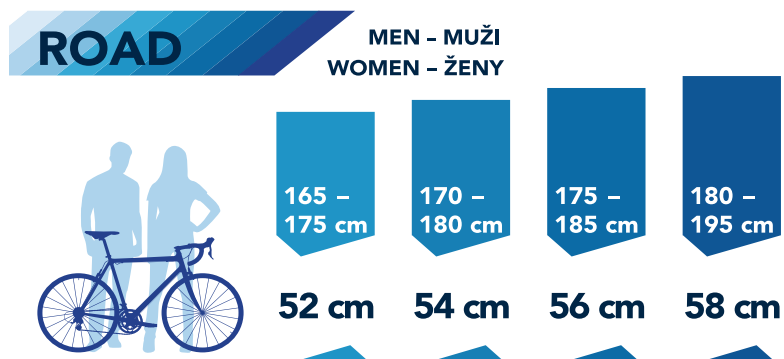

Size chart refers only as a guide and a test at your dealer is a need/ Veľkostná tabuľka je len orientačná a nevyrovná sa testovacej jazde u Vášho predajcu

Heights are based on the min-max 30-35 cm long seat tube / Výšky vychádzajú z min-max sedlovej rúrky dlhej 30-35cm

GEOMETRY / GEOMETRIA RÁMOV

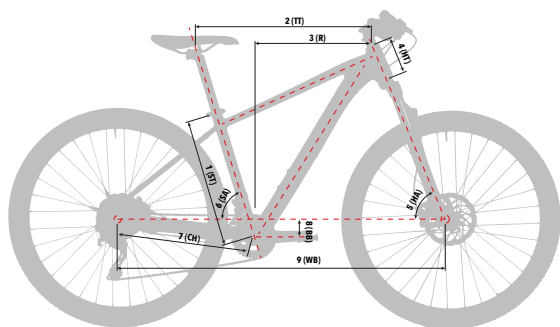

FRAME SIZES (mm) / ROZMERY RÁMOV (mm)

1 (ST)	SEAT TUBE LENGTH / DĹŽKA SEDLOVKY
2 (TT)	HORIZONTAL TOPTUBE LENGTH / HORIZONTÁLNA DĹŽKA HODNOTA
3 (R)	REACH / DOSAH
4 (HT)	HEADTUBE LENGTH / DĹŽKA HLAVOVKY
5 (HA)	HEAD ANGLE / UHOL HLAVY
6 (SA)	SEAT ANGLE / UHOL SEDLOVKY
7 (CH)	CHAINSTAY LENGTH / DĹŽKA DOLNEJ STAVBY
8 (BB)	BB DROP / VÝŠKA STREDU
9 (WB)	WHEELBASE LENGTH / DĹŽKA RÁZVORU KOLIES

E-BIKE

E-XONIC	w42 cm	w46 cm	m48 cm	m53 cm	m56 cm
1 (ST)	420	460	483	530	560
2 (TT)	483,6	509	556,6	591,3	598,3
3 (R)	360,8	375	414,8	434	436
4 (HT)	180	180	180	180	180
5 (HA)	71°	71°	71°	71°	71°
6 (SA)	73°	73°	73°	73°	73°
7 (CH)	465	465	465	465	465
8 (BB)	60	60	60	60	60
9 (WB)	1071,8	1071,8	1126,5	1146,5	1146,5

VINTI GO	49 cm
1 (ST)	490
2 (TT)	640
3 (R)	426
4 (HT)	190
5 (HA)	71°
6 (SA)	71°
7 (CH)	465
8 (BB)	50
9 (WB)	1125,3

RETRO GO	49 cm
1 (ST)	490
2 (TT)	624,7
3 (R)	411,8
4 (HT)	190
5 (HA)	71°
6 (SA)	71°
7 (CH)	510
8 (BB)	50
9 (WB)	1117,4

E-DREAM	46 cm
1 (ST)	460
2 (TT)	580
3 (R)	395
4 (HT)	170
5 (HA)	69°
6 (SA)	72,5°
7 (CH)	429
8 (BB)	35
9 (WB)	1082,4

ROAD

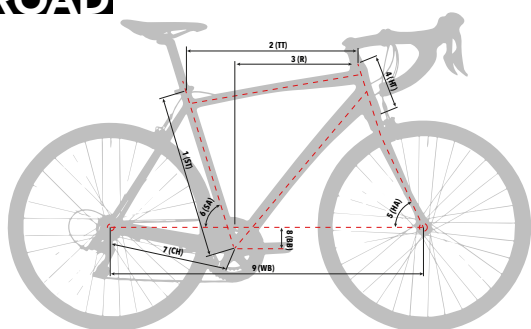

ATTRACTIVE	54cm	56cm	58cm
1 (ST)	500	520	540
2 (TT)	562,5	573,6	597,4
3 (R)	397	400	418
4 (HT)	145	165	185
5 (HA)	72°	72,5°	72,5°
6 (SA)	73,5°	73,2°	73,4°
7 (CH)	405	405	405
8 (BB)	70	70	70
9 (WB)	1000	1005	1029

CALIBRE	52cm	54cm	56cm	58cm
1 (ST)	520	540	560	580
2 (TT)	573,6	578,5	583,6	588,3
3 (R)	402	406	410	411
4 (HT)	165	165	165	185
5 (HA)	72,5°	72,5°	72,5°	72,5°
6 (SA)	73°	73°	73°	73°
7 (CH)	405	405	405	405
8 (BB)	70	70	70	70
9 (WB)	1005	1010	1015	1015

CALIBRE	48cm	50cm	52cm	54cm	56cm	58cm
1 (ST)	480	500	520	540	560	580
2 (TT)	522,7	527,7	548	562,5	574	602
3 (R)	383	388	394	398	399	414
4 (HT)	125	125	125	145	175	205
5 (HA)	72°	72°	72	72°	72,5°	72,5°
6 (SA)	75,5°	75,5°	74	73,5°	73,2°	73,4°
7 (CH)	405	405	405	405	405	405
8 (BB)	70	70	70	70	70	70
9 (WB)	980	985	990	1000	1005	1029

Q (kju:) 29"	m15"	w16"	m17"	w18"	m19"	m21"	m23"
1 (ST)	381	406	432	457	483	533	584
2 (TT)	505	503,5	539,5	536,5	575	607	639
3 (R)	396	388	412,7	406	436	453,7	470,4
4 (HT)	110	130	110	130	115	125	135
5 (HA)	70°	70°	70°	70°	70°	70°	70°
6 (SA)	74,6°	74,6°	74,6°	74,6°	74,6°	74,6°	74,6°
7 (CH)	455	455	455	455	455	455	455
8 (BB)	60	60	60	60	60	60	60
9 (WB)	1100	1161,1	1161,1	1116,1	1141	1161,8	1182,3

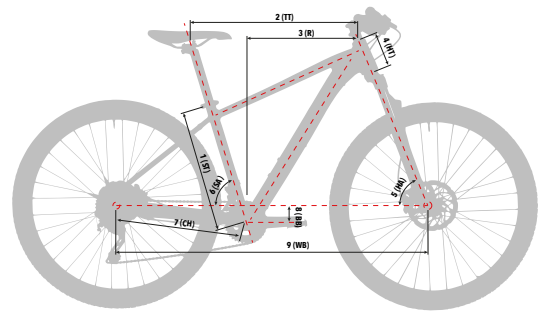

SHADE 29"	w16"	m17"	w18"	m19"	m21"
1 (ST)	406	432	457	483	533
2 (TT)	592,6	592,6	592,6	592,6	614
3 (R)	411	411	412	412	433
4 (HT)	130	130	130	130	130
5 (HA)	71°	71°	71°	71°	71°
6 (SA)	73,9°	73,9°	73,9°	73,9°	73,9°
7 (CH)	450	450	450	450	450
8 (BB)	60	60	60	60	60
9 (WB)	1093,2	1093,2	1093,2	1093,2	1113,3

Q (kju:) 27,5"	w16"	m17"	w18"	m19"	m21"
1 (ST)	406	432	457	483	533
2 (TT)	514,5	538,5	540	579,4	614,8
3 (R)	396,5	415,7	406	441	460,8
4 (HT)	130	110	110	110	110
5 (HA)	71°	70,5°	71°	70,5°	70,5°
6 (SA)	74°	75,8°	74°	75,8°	75,8°
7 (CH)	430	440	430	440	440
8 (BB)	53	53	53	53	53
9 (WB)	1065,5	1073	1075,2	1102	1083,4

SHADE 27,5"	w16"	m17"	w18"	m19"	m21"
1 (ST)	406	432	457	483	533
2 (TT)	591	592	592	592	604
3 (R)	410	410	409	409	423
4 (HT)	130	130	130	130	130
5 (HA)	71°	71°	71°	71°	70,4°
6 (SA)	73°	73°	73°	73°	73°
7 (CH)	445	445	445	445	445
8 (BB)	45	45	45	45	45
9 (WB)	1082,1	1082,1	1082,1	1072,2	1101,2

SHADE 26"	13"	15"	w16"	m17"	w18"	m19"	m21"
1 (ST)	303	381	406	432	457	483	533
2 (TT)	488	492	510	518,2	525,8	532,3	568,5
3 (R)	392	381	392	392	392	392	412
4 (HT)	130	130	130	130	130	130	130
5 (HA)	70°	70°	70,5°	70,5°	70°	70°	70°
6 (SA)	73°	73°	73°	73°	73°	73°	73°
7 (CH)	420	420	420	420	420	420	420
8 (BB)	30	30	30	30	30	30	30
9 (WB)	1043,2	1043,2	1043,2	1043,2	1043,2	1043,2	1063,2

DISTANCE	w44cm	w48cm	m48cm	m51cm	m56cm
1 (ST)	440	480	480	510	560
2 (TT)	574	581	581	584	591
3 (R)	376	382	382	385	392
4 (HT)	185	185	185	185	185
5 (HA)	71,5°	71,5°	71,5°	71,5°	71,5°
6 (SA)	73,5°	73,5°	73,5°	73,5°	73,5°
7 (CH)	445	445	445	445	445
8 (BB)	70	70	70	70	70
9 (WB)	1069,6	1076,6	1076,6	1079,6	1086,6

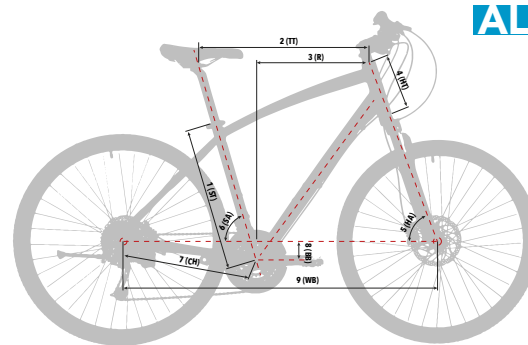

STROLLER	w44cm	w48cm	m48cm	m51cm	m56cm
1 (ST)	440	480	480	510	560
2 (TT)	590	591	591	592	592
3 (R)	390	392	392	399	399
4 (HT)	180	180	180	180	180
5 (HA)	71,3°	71,3°	71,3°	71,3°	71,3°
6 (SA)	73,3°	73,3°	73,3°	73,3°	73,3°
7 (CH)	448	448	448	448	448
8 (BB)	55	55	55	55	55
9 (WB)	1082	1082	1082	1082	1082

ARWEN	w44cm	w48cm	m48cm	m51cm	m56cm
1 (ST)	440	480	480	510	560
2 (TT)	580	580	580	580	580
3 (R)	405	405	405	405	405
4 (HT)	150	150	150	150	150
5 (HA)	69°	69°	69°	69°	69°
6 (SA)	73°	73°	73°	73°	73°
7 (CH)	455	455	455	455	455
8 (BB)	50	50	50	50	50
9 (WB)	1105,7	1105,7	1105,7	1105,7	1105,7

URBAN

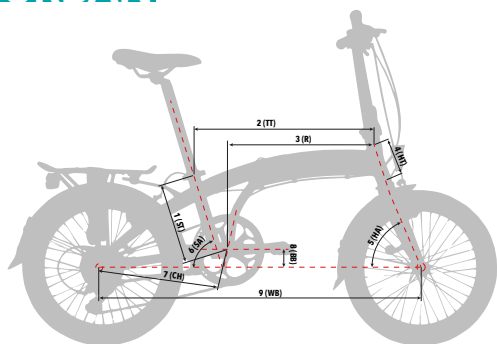

ECOPOLIS	29cm
1 (ST)	290
2 (TT)	590
3 (R)	462
4 (HT)	105
5 (HA)	73°
6 (SA)	76°
7 (CH)	400
8 (BB)	37,5
9 (WB)	1021,3

SIMPLYCITY	29cm
1 (ST)	289,3
2 (TT)	593,2
3 (R)	460
4 (HT)	105
5 (HA)	73°
6 (SA)	76°
7 (CH)	400
8 (BB)	37,5
9 (WB)	1021,3



FIXIE	W48cm	M49cm	M54cm
1 (ST)	480	490	540
2 (TT)	525	525	555
3 (R)	373	369	388
4 (HT)	110	110	135
5 (HA)	73°	73°	73°
6 (SA)	73,5°	73,5°	73,5°
7 (CH)	405	405	405
8 (BB)	65	65	65
9 (WB)	967	947	977

COMFORT

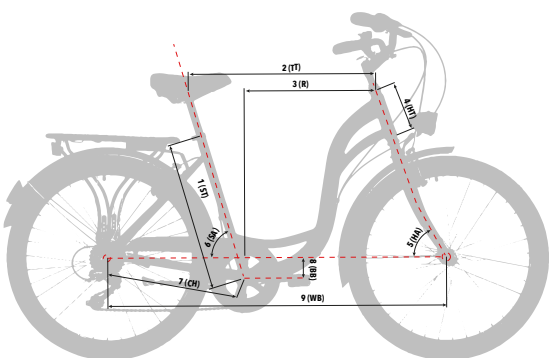

DREAM	AL 26"	ST 26"	AL 28"	ST 28"
	46 cm	46 cm	49 cm	46 cm
1 (ST)	460	460	490	460
2 (TT)	580	588	622,6	604
3 (R)	395	397	425	415
4 (HT)	170	160	190	160
5 (HA)	69°	69°	69°	69°
6 (SA)	72,5°	72,5°	73°	72,5°
7 (CH)	429	440	465	460
8 (BB)	35	60	60	70
9 (WB)	1082,4	1093,3	1148,5	1126

AVENUE	46 cm
1 (ST)	460
2 (TT)	580
3 (R)	395
4 (HT)	170
5 (HA)	69°
6 (SA)	72,5°
7 (CH)	429
8 (BB)	35
9 (WB)	1082,4

SILUET	46 cm
1 (ST)	460
2 (TT)	552,5
3 (R)	398
4 (HT)	150
5 (HA)	69°
6 (SA)	62°
7 (CH)	455
8 (BB)	55
9 (WB)	1091,7

CORSO	44 cm
1 (ST)	444
2 (TT)	585
3 (R)	408
4 (HT)	140
5 (HA)	69°
6 (SA)	74°
7 (CH)	445
8 (BB)	70
9 (WB)	1111

BOULEVARD	44 cm
1 (ST)	432
2 (TT)	583
3 (R)	422
4 (HT)	140
5 (HA)	69°
6 (SA)	74°
7 (CH)	440
8 (BB)	60
9 (WB)	1103

CRUISER	W46 cm	M46 cm
1 (ST)	457	460
2 (TT)	624,6	627,7
3 (R)	461	462
4 (HT)	150	150
5 (HA)	73°	73°
6 (SA)	73,5°	73,5°
7 (CH)	476	476
8 (BB)	35	35
9 (WB)	1110	1140

NOSTALGIC PRESTIGE / DELUXE	49 cm
1 (ST)	490
2 (TT)	640
3 (R)	426
4 (HT)	190
5 (HA)	71°
6 (SA)	71°
7 (CH)	465
8 (BB)	50
9 (WB)	1125,3

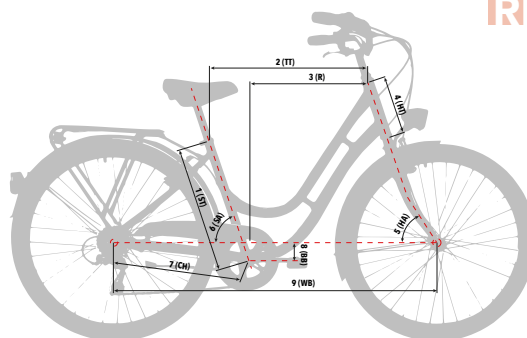

NOSTALGIC ROYAL / CLASSIC / CEREMONY	43 cm	49 cm
1 (ST)	430	460
2 (TT)	593,5	640
3 (R)	393	426
4 (HT)	190	190
5 (HA)	61°	61°
6 (SA)	71°	71°
7 (CH)	440	465
8 (BB)	35	50
9 (WB)	1067,6	1125,3

MONTERREY	51 cm	56 cm
1 (ST)	510	560
2 (TT)	607,6	607,6
3 (R)	423	423
4 (HT)	160	160
5 (HA)	71°	71°
6 (SA)	73°	73°
7 (CH)	450	450
8 (BB)	65	65
9 (WB)	1096	1096

LUIGI	60 cm
1 (ST)	600
2 (TT)	612
3 (R)	383
4 (HT)	180
5 (HA)	67°
6 (SA)	67,5°
7 (CH)	485
8 (BB)	61,5
9 (WB)	1155

MALENA	55 cm
1 (ST)	550
2 (TT)	566
3 (R)	356
4 (HT)	250
5 (HA)	67°
6 (SA)	67,5°
7 (CH)	485
8 (BB)	61,5
9 (WB)	1144,5

BELLISSIMA	AL 26"	ST 26"
1 (ST)	460	460
2 (TT)	580	588
3 (R)	395	397
4 (HT)	170	160
5 (HA)	69°	69°
6 (SA)	72,5°	72,5°
7 (CH)	429	440
8 (BB)	35	60
9 (WB)	1082,4	1093,3

SIGNORA	28"
1 (ST)	444
2 (TT)	585
3 (R)	408
4 (HT)	140
5 (HA)	69°
6 (SA)	74°
7 (CH)	445
8 (BB)	70
9 (WB)	1111

MISSY	26"
1 (ST)	432
2 (TT)	583
3 (R)	422
4 (HT)	140
5 (HA)	69°
6 (SA)	74°
7 (CH)	440
8 (BB)	60
9 (WB)	1103

ZIGGY	20"	16"	12"
1 (ST)	250	240	200
2 (TT)	456,8	377	291,7
3 (R)	311	265	209
4 (HT)	100	90	90
5 (HA)	70°	71°	71°
6 (SA)	70°	71°	72°
7 (CH)	363	315	245
8 (BB)	5	15	40
9 (WB)	874	719,4	574

RARITY	24"
1 (ST)	
2 (TT)	
3 (R)	
4 (HT)	
5 (HA)	
6 (SA)	
7 (CH)	
8 (BB)	
9 (WB)	

MINI/KIDS/TEENS

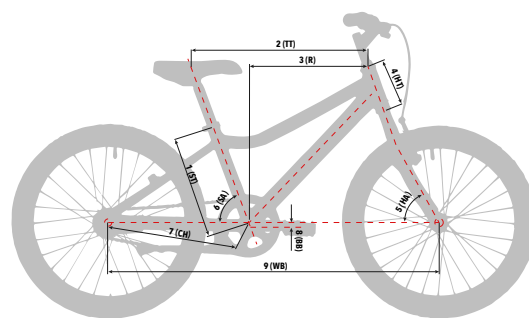

VULCANO	24"
1 (ST)	300
2 (TT)	527,5
3 (R)	361
4 (HT)	120
5 (HA)	70°
6 (SA)	72,2°
7 (CH)	420
8 (BB)	22
9 (WB)	1000,8

SHADE 26"	13"	15"
1 (ST)	303	381
2 (TT)	488	492
3 (R)	392	381
4 (HT)	130	130
5 (HA)	70°	70°
6 (SA)	73°	73°
7 (CH)	420	420
8 (BB)	30	30
9 (WB)	1043,2	1043,2

CALIBRE	48 cm	50 cm
1 (ST)	480	500
2 (TT)	522,7	527,7
3 (R)	383	388
4 (HT)	125	125
5 (HA)	72°	72°
6 (SA)	75,5°	75,5°
7 (CH)	405	405
8 (BB)	70	70
9 (WB)	980	985

TECHZONE / TECHNOLOGIE



ADJUSTABLE STEM
Nastavitelný predstavec



AIR FORK
Vzduchová vidlica



AIR LIGHT ROAD DESIGN
Odlahčený cestný dizajn



BOY FITTED GEOMETRY
Geometria a použité komponenty prispôsobené ergonomii a telesným proporciám detí (chlapcov) pre jednoduché, komfortné a bezpečné ovládanie.



CARBON FORK
Minimalizácia hmotnosti a zvýšenie tuhosti. Karbónová vidlica ponúka vysokú tuhosť a schopnosť absorbovať vibrácie, pri zachovaní nízkej hmotnosti. Výsledkom je výborná ovládateľnosť a jazdný komfort.



COMFI SIT
Pohodlné sedlo, ktoré ľahko zvládne cestné nerovnosti a tlmí nárazy.



COMFORTABLE GRIPS
Anatomicky tvarované rukoväte poskytujúce komfort a bezpečné uchopenie.



COMPACT CRANKSET
Kompaktné kľuky ponúkajúce rozsah prevodov, ktoré umožnia zložiť aj náročnejšie stúpania.



CUSTOMIZED HYDROFORMING TUBE SHAPING
Na záklaku tvarované trubky technológiou hydroforming, pomocou vysokotlakového lisu a oleja. Tepelne spracovaná kombinácia zliatiny hliníka s hlavnou prímiesou Mg sa vyznačuje výbornou tvarovateľnosťou a pomerom tuhosti a hmotnosti.



DOUBLE BUTTED TUBE
Konštrukcia rámu vyhotovená z trubiek zo zužovaného materiálu, pri ktorom sa znižuje hmotnosť a zachováva tuhosť.



E-BIKE
Bicykel s elektrickým pohonom, ktorý je aktivovaný šliapaním do pedálov.



EASY FASTENING
Ľahké a jednoduché uchytenie



ECO POWDER COATING
Ekologická povrchová úprava s aplikáciou práškových farieb, ktoré sú šetrné k životnému prostrediu, šetria energiu a zdroje, neobsahujú rozpúšťadlá, iné prchavé organické látky a ponúkajú trvalú a odolnú ochranu.



FIVE LEVELS
Voľba 5 režimov asistencie motora pri šliapaní u elektrobicyklov.



FULLY EQUIPPED BIKE
Bicykel v plnej výbave



GIRL FITTED GEOMETRY
Geometria a použité komponenty prispôsobené ergonomii a telesným proporciám detí (dievčat) pre jednoduché, komfortné a bezpečné ovládanie.



GREEN RUBBER
Plášte vyrobené zo 100% recyklovateľného a obnoviteľného materiálu.



HYDRAULIC DISC BRAKE
Hydraulické kotúčové brzdy sú najúčinnším brzdným systémom za akýchkoľvek poveternostných podmienok.



HYFORK
Ľahká hliníková vidlica zo špeciálnej zliatiny v kombinácii so spracovaním pomocou vysokotlakového lisu a oleja sa vyznačuje výbornou tvarovateľnosťou a tuhosťou.



INNER CABLE ROUTING
Vnútorne vedenie káblov chráni káble pred vonkajšími vplyvmi ako voda, prach a iné nečistoty a zároveň prispieva k dokonalejšiemu vzhľadu bicykla.



INTEGRATED BRAKE SYSTEM
Rear disc brake post mount connection gives smaller tension to rear side with stronger braking power.



IZY-FOLP
Praktické skladacie pedále.



LIGHT WEIGHT
Konštrukcia rámu s nízkou hmotnosťou.



LOW STEP IN
Nízokoprešlapový rám pre komfortnejšie a bezpečnejšie nastupovanie a zostupovanie z bicykla.



MAGNETICC
Systém magnetického držáku pomocou ktorého je rám pevne fixovaný.



MAX 25 KM/H
Maximálna rýchlosť. Podpora motora u elektrobicyklov sa vypína pri dosiahnutí 25km/h.



MECHANICAL DISC BRAKE
Mechanické diskové brzdy



RACE GEOMETRY
Geometria rámu prispôsobená pre agresívnejšiu športovejšiu jazdu.



REFLECTIVE LINE
Reflexné pásy na pláštach sú jasne viditeľné pri osvetlení autom. Reflexný materiál odráža žiarenie v smere zdroja. Reflexné pásy umiestnené z oboch strán plášta robia cyklistu viditeľného a ľahko rozpoznateľného.



REMOTE LOCKOUT
Vzdialené uzamykanie vidlice bez potreby opustiť rukami riadítka. 100% kontrola riadenia po celý čas jazdy.



RIDE N' FOLD
Skladací mechanizmus pomocou ktorého bicykel ľahko zložíte za pár sekúnd.



RIGID FORK
Pevná vidlica



REAR SUSPENSION SYSTEM
Rear Suspension proactive system is efficient when pedalling and braking phase, too. Designed to maintain the chain link unchanged in damping phase which avoids transmission problems.



SMOOTH WELDING
Technológia zvárania, pri ktorom sa zvar vyhladí pre čistejší dizajn a zároveň zachová potrebnú pevnosť a životnosť.



SPEED LOCKOUT
Mechanické uzamykanie pruženia vidlice.



SUPER BRIGHT LED
Vysokosvietivé LED diódy



SUSPENSION FORK
Odpružená vidlica



TAPERED HEAD TUBE
Kónická hlavová trubka využívajúca spodné ložisko s väčším priemerom, čo zvyšuje životnosť, tuhosť a ovládateľnosť.



TRIPLE BUTTED TUBE
Konštrukcia rámu vyhotovená z trubiek zo zužovaného materiálu, pri ktorom sa znižuje hmotnosť a zachováva tuhosť.



WHEEL SIZE
Veľkosť kolies 12"/16"/20"/24"/26"/27,5"/28"/29"



WOMAN FITTED GEOMETRY
Geometria a použité komponenty prispôsobené ergonomii a telesným proporciám žien pre jednoduché, komfortné a bezpečné ovládanie.

DICTIONARY / SLOVNÍK POJMOV

SLOVENČINA 	ČEŠTINA 	DEUTSCH 	MAGYAR 	ROMÂNESC 	POLSKI 
Rám	Rám	Rahmen	Váz	Cadru	Rama
Vidlica	Vidlice	Gabel	Villa	Furca	Widelec
Velkost rámu	Výška rámu	Rahmengröße	Vázméret	Dimensiunea cadrului	Rozmiar ramki
Velkost kolies	Velikost kol	Radgröße	Kerékméret	Dimensiunea roții	Rozmiar koła
Předný náboj	Přední náboj	Nabe VR	Első agy	Butuc fata	Piasta przednia
Zadný náboj	Zadní náboj	Nabe HR	Hátsó agy	Butuc spate	Tylna piasta
Radenie	Řazení	Schaltung	Váltókar	Manete schimbator	Manetki
Prehadzovačka	Měníč	Schaltwerk	Hátsó váltó	Schimbator spate	Przerzutka tył
Prešmykač	Přesmyk	Kettenwerfer	Első váltó	Schimbator fata	Przerzutka przód
Refáz	Řetěz	Kette	Lánc	Laț	Guarnitura
Kluky	Kliky	Kettenradgarnitur	Hajtómű	Angrenaj	Wolnobieg
Kazeta	Vícekolečko	Zahnkranz	Fogaskoszorú	Pinioane	Kaseta
Brzdy	Brzdy	Bremsen	Fék	Frane	Hamulce
Tlmič	Tlumič	Dämpfer	Teleszkóp	Amortizor spate	Tylny amortyzator
Pohon	Pohon	Antrieb	Motor	Unitate de antrenare	Jednostka napędowa
Batéria	Batéria	Batterie	Akkumulátor	Baterie	Bateria
Displej	Displej	Display	Kijelző	Afișa	Pokaz
Režim	Režim	Assistance-Ebene	Rásegítési szint	Regim	Poziom assistance

ENGLISH 	ITALIANO 	EESTI 	LIETUVOS 	LATVIJAS 	HRVATSKI 
Frame	Telaio	Raam	Kadras	Rāmis	Okvir
Fork	Forcella	Kahvel	Šakės	Dakša	Viljuška
Frame size	Dimensione del frame	Raami suurus	Rėmo dydis	Rāmja izmērs	Veličina okvira
Wheel size	Dimensioni ruote	Ratta suurus	Ratų dydis	Riteņu izmēri	Veličina kotača
Front hub	Mozzo anteriore	Front hub	Priekinė stebulė	Priekšējais rumba	Prednja glavčina
Rear hub	Mozzo posteriore	Tagarumme	Galinė stebulė	Aizmugurējā rumba	Stražnja glavčina
Shifters	Comandi cambio	Käiguvahetajad	Keitiklis	Mainītājs	Mjenjača
Rear derailleur	Cambio posteriore	Tagumine käiguvahetaja	Galinis pavarų perjungiklis	Aizmugurējais pārslēdzējs	Stražnji mjenjač
Front derailleur	Deragliatore	Eesmine käiguvahetaja	Priekinis pavarų perjungiklis	Priekšējais pārslēdzējs	Prednji mjenjač
Chain	Catena	Kett	Grandinė	Kēde	Lanac
Crank set	Guarnitura	Vāndad	Korba	Pārveidotājs ar crank	Pretvarač s polugom
Freewheel	Ruota libera	Vabakäiguga sõitma	Važiuoti į pakalnę	Kasete	Kaseta
Brakes	Freni	Pidurid	Stabdžiai	Bremzes	Kočnice
Rear shock	Ammortizzatore posteriore	Tagumine šokk	Galinis amortizatorius	Trokšņa slāpētājs	Stražnji shock
Drive unit	Trazione	Ajam	Variškis	Dzinējs	Pogon
Battery	Torcia elettrica	Aku	Baterija	Baterija	Baterija
Display	Display	Ekraan	Displėjus	Displejs	Prikaz
Assistance level	Regime	Kord	Režimas	Režims	Razina pomoć

PREDAJNÁ SIĚŤ / SALES NETWORK

Rakúsko		Austria
Chorvátsko		Croatia
Česká republika		Czech Republic
Estónsko		Estonia
Nemecko		Germany
Maďarsko		Hungary
Írsko		Ireland
Litva		Latvia
Lotyšsko		Lithuania
Poľsko		Poland
Rumunsko		Romania
Slovensko		Slovakia
Slovinsko		Slovenia
Švajčiarsko		Switzerland

MASTHEAD / TIRÁŽ

Photo

Matúš Lago / Sportmedia s.r.o. / Michaela Luptáková / Eva Kramerová / Monika Valigurová / Diana Mráziková

Text

Monika Božiková / Michal Lariš / Miklós Kaposi

Special thanks to

Barbora Palovičová and her team of Miss Folklor, Peťka & Christian, Teo & Simon, Marcela and Emma, Lenka and Suri, Lucka and Mila & Alanko, Lenka and Lucas & Andreas, Sonka and Miško, Zuzka, Domini and Natálka & Karolínka, Babička Margita, Števko, Magenta Aupark Bratislava, all employees of KENZEL - to each one of you who was part of this long and sometimes difficult development process of our 2020 collection which we are now proud to present and to the graphic department.

All rights reserved © Jozef Kender - KENZEL © KENZEL s.r.o.

We reserve the right to change at any moment and without warning the technical specifications of our products as they are presented in this catalogue. Products shown may not be available in all regions, please check with your local retailer for availability. During continuous improvement the specifications and design are changing. Illustrations do not necessarily show the design of every version and some features are version specific. We are not liable for errors, changes or misprints.

Check www.kenzel.sk

Foto

Matúš Lago / Sportmedia s.r.o. / Michaela Luptáková / Eva Kramerová / Monika Valigurová / Diana Mráziková

Texty

Monika Božiková / Michal Lariš / Miklós Kaposi

Špeciálne poďakovanie

Barbora Palovičová a jej tím Miss Folklor, Peťka a Christian, Teo a Simon, Marcela a Emma, Lenka a Suri, Lucka a Mila & Alanko, Lenka a Lucas a Andreas, Sonka a Miško, Zuzka, Domini a Natálka a Karolínka, Babička Margita, Števko, Magenta Aupark Bratislava, a v neposlednom rade všetkým zamestnancom spoločnosti KENZEL - každému jednému, ktorý bol súčasťou výroby dlhého a niekedy náročného, ale zároveň vzrušujúceho procesu prípravy kolekcie 2020, ktorú v tomto katalógu hrdó prezentujeme. Vďaka patrí aj grafickému oddeleniu, ktoré sa podieľalo na grafickej realizácii katalógu.

Všetky práva vyhradené © Jozef Kender - KENZEL © KENZEL s.r.o.

Spoločnosť Jozef Kender - KENZEL a KENZEL s.r.o. si vyhradzuje právo zmien, ktoré môžu nastať po vydaní tohto katalógu. Zmena špecifikácií je vyhradená. Produkty prezentované v katalógu nemusia byť dostupné v každom regióne, o dostupnosti sa informujte u najbližšieho predajcu. Pre viac informácií navštívte

www.kenzel.sk

Images available online can be used free of rights as long as they are used to promote brand Kenzel.

To download product images sorted by models or for other requests related to marketing, please contact us at kenzel@kenzel.sk.

Fotografie sú voľne použiteľné pokiaľ sú používané na podporu značky Kenzel.

V prípade požiadaviek o produktové fotografie modelov, prípadne ďalších otázok a požiadaviek ohľadne marketingových záležitostí, prosím kontaktujte nás na kenzel@kenzel.sk.

KENZEL S.R.O.
Novozámocká 182, Hurbanovo 947 01
Slovensko/Slovakia
tel./fax: +421 35 761 0165, +421 35 761 0085
e-mail: kenzel@kenzel.sk



KENZELBICYCLESERIES



KENZELBIKES



KENZEL BICYCLES

THANK YOU FOR CHOOSING
#KENZELBIKES

ĎAKUJEME, ŽE STE SI VYBRALI
KENZEL BICYKLE



www.kenzel.sk

DEALER / PREDAJCA:

